

## Copyright Information

Copyright © 2020 by LAUNCH TECH CO., LTD. All rights reserved. No part of this publication may be reproduced, stored in a retrieval system, or transmitted in any form or by any means, electronic, mechanical, photocopying, recording or otherwise, without the prior written permission of LAUNCH. The information contained herein is designed only for the use of this unit. LAUNCH is not responsible for any use of this information as applied to other units.

Neither LAUNCH nor its affiliates shall be liable to the purchaser of this unit or third parties for damages, losses, costs, or expenses incurred by purchaser or third parties as a result of: Accident, misuse, or abuse of this unit, or unauthorized modifications, repairs, or alterations to this unit, or failure to strictly comply with LAUNCH operating and maintenance instructions. LAUNCH shall not be liable for any damages or problems arising from the use of any options or any consumable products other than those designated as Original LAUNCH Products or LAUNCH Approved Products by LAUNCH.

## Trademark Information

LAUNCH is a registered trademark of LAUNCH TECH CO., LTD. (LAUNCH) in China and other countries. All other LAUNCH trademarks, service marks, domain names, logos, and company names referred to in this manual are either trademarks, registered trademarks, service marks, domain names, logos, company names of or are otherwise the property of LAUNCH or its affiliates. In countries where any of the LAUNCH trademarks, service marks, domain names, logos and company names are not registered, LAUNCH claims other rights associated with unregistered trademarks, service marks, domain names, logos, and company names. Other products or company names referred to in this manual may be trademarks of their respective owners. You may not use any trademark, service mark, domain name, logo, or company name of LAUNCH or any third party without permission from the owner of the applicable trademark, service mark, domain name, logo, or company name. You may contact LAUNCH by visiting the website at [www.cnlaunch.com](http://www.cnlaunch.com), or writing to LAUNCH TECH CO., LTD., Launch Industrial Park, North of Wuhe Avenue, Banxuegang, Bantian, Longgang, Shenzhen, Guangdong, P.R.China, to request written permission to use Materials on this manual for purposes or for all other questions relating to this manual.

## Important Safety Information

**Warning:** To avoid personal injury, property damage, or accidental damage to the product, read all of the information in this section before using the product.

### Work Area Safety

- Keep work area clean and well lit. Cluttered benches and dark areas may cause accidents.
- Do not connect or disconnect the tool while the ignition is on or the engine is running.
- DO NOT attempt to operate the tool while driving the vehicle. Have a second person to operate the tool.
- Before testing a vehicle, put the transmission in PARK (for automatic transmission) or NEUTRAL (for manual transmission). Engage the parking brake and chock the tires.
- NEVER smoke or allow a spark or flame in vicinity of battery or engine.
- The vehicle shall be tested in a well-ventilated work area, as engines produce various poisonous compounds (hydrocarbon, carbon monoxide, nitrogen oxides, etc.)
- Do not operate the tool in explosive atmospheres, such as in the presence of flammable liquids, gases, or heavy dust.
- Never leave the vehicle unattended while testing.
- Keep a fire extinguisher suitable for gasoline/chemical/electrical fires nearby.
- Use extreme caution when working around the ignition coil, distributor cap, ignition wires and spark plugs. These components create hazardous voltages when the engine is running.
- Keep bystanders, children and visitors away while operating the tool.
- This product is not a toy. Do not allow children to play with or near this tool.
- Use as intended only. Do not modify.
- Inspect before every use; do not use if parts are loose or damaged.
- Do not place the tool on any unstable surface.
- Handle the tool with care. If the tool is dropped, check for breakage and any other conditions that may affect its operation.
- Keep the tool dry, clean, free from oil, water or grease. Use a mild detergent on a clean cloth to clean the outside of the tool when necessary.
- Store the tool and accessories in a locked area out of the reach of children.
- To avoid damaging the tool or generating false data, please make sure the vehicle battery is fully charged and the connection to the vehicle DLC (Data Link Connector) is clear and secure.
- If the VCI (Vehicle Communication Interface) is not in use for a long period of time, it is suggested to unplug the VCI from vehicle's DLC to conserve battery power.

### Electrical Safety

- Do not use the tool while standing in water.
- Avoid body contact with grounded surfaces such as pipes, radiators, ranges and refrigerators.
- **Do not expose the tool or power adaptor to rain or wet conditions.** Water entering the tool or power adaptor increases the risk of electric shock.

### Personal Safety

- Wear an ANSI-approved eye shield when testing or repairing vehicles.
- Do not wear loose clothing or jewelry. Keep hair, clothing, hands, tools, and test equipment away from moving or hot engine parts. Loose clothes, jewelry, or long hair can be caught in moving parts.
- Do not use the tool while tired or under the influence of drugs, alcohol, or medications. A moment of interruption can result in serious personal injury.
- People with pacemakers should consult their physician(s) before use. Electromagnetic fields in close proximity to heart pacemaker could cause pacemaker interference or pacemaker failure.

- The warnings, precautions, and instructions discussed in this instruction manual cannot cover all possible conditions and situations that may occur. It must be understood by the operator that common sense and caution are factors which cannot be built into this product, but must be supplied by the operator.
- There are no user serviceable parts. Have the tool serviced by a qualified repair person using only identical replacement parts. This will ensure that the safety of the equipment is maintained.
- Please use the included battery and charger. Risk of explosion if the battery is replaced with an incorrect type.
- Automotive batteries contain sulfuric acid that is harmful to skin. In operation, direct contact with the automotive batteries should be avoided. Keep the ignition sources away from the battery at all times.

**Precautions on Operating Vehicle's ECU**

- Do not disconnect battery or any wiring cables in the vehicle when the ignition switch is on, as this could avoid damage to the sensors or the ECU.
- Do not place any magnetic objects near the ECU. Disconnect the power supply to the ECU before performing any welding operations on the vehicle.
- Use extreme caution when performing any operations near the ECU or sensors. Ground yourself when you disassemble PROM, otherwise ECU and sensors can be damaged by static electricity.
- When reconnecting the ECU harness connector, be sure it is attached firmly, otherwise electronic elements, such as ICs inside the ECU, can be damaged.

**TABLE OF CONTENTS**

**1 INTRODUCTION..... 1**

1.1 PRODUCT PROFILE ..... 1

1.2 FEATURES..... 1

1.3 COMPONENTS & CONTROLS..... 1

    1.3.1 Display Tablet ..... 2

    1.3.2 SmartLink C Device ..... 3

1.4 TECHNICAL PARAMETERS ..... 4

    1.4.1 Display tablet ..... 4

    1.4.2 SmartLink C device ..... 5

1.5 PACKAGE LIST (ONLY FOR PASSENGER VEHICLE CONFIGURATION) ..... 5

1.5 PACKAGE LIST (ONLY FOR COMMERCIAL VEHICLE CONFIGURATION) ..... 5

1.5 PACKAGE LIST (ONLY FOR GASOLINE & DIESEL CONFIGURATION) ..... 6

**2 PREPARATIONS ..... 8**

2.1 CHARGING THE TABLET..... 8

2.2 USING BATTERY ..... 8

2.3 POWER ON/OFF ..... 8

    2.3.1 Power on ..... 8

    2.3.2 Power off ..... 8

2.4 TIPS ON FINGER OPERATIONS ..... 8

2.5 SCREEN LAYOUT ..... 8

2.6 ADJUST BRIGHTNESS ..... 9

2.7 CHANGE SYSTEM LANGUAGE ..... 9

2.8 SET STANDBY TIME ..... 9

**3 NETWORK SETUP..... 10**

3.1 CONNECT TO A WLAN NETWORK ..... 10

3.2 DISCONNECT FROM A WLAN NETWORK ..... 10

**4 INITIAL USE ..... 11**

4.1 DIAGNOSIS FLOWCHART ..... 11

4.2 GETTING STARTED ..... 11

    4.2.1 Register & Update ..... 11

    4.2.2 Job menu ..... 13

    4.2.3 Diagnostics toolbar ..... 14

4.3 CONNECTIONS..... 14

    4.3.1 Preparation ..... 14

    4.3.2 DLC location ..... 15

    4.3.3 Vehicle connection (For Passenger Vehicle Configuration)..... 15

    4.3.3 Vehicle connection (For Commercial Vehicle/Gasoline & Diesel Vehicle Edition) ..... 16

4.4 DIAGNOSTIC TROUBLE CODES (DTCs) ..... 16

**5 DIAGNOSIS ..... 18**

5.1 INTELLIGENT DIAGNOSE ..... 18

5.2 LOCAL DIAGNOSE ..... 20

    5.2.1 Health Report (Quick Test) ..... 24

5.2.2 System Scan .....	26
5.2.3 System Selection.....	27
5.3 REMOTE DIAGNOSE .....	34
5.3.1 Interface Layout.....	34
5.3.2 Add Friends .....	34
5.3.3 Start Instant Messaging .....	35
5.3.4 Launch Remote Diagnosis (Device-To-Device).....	36
5.3.5 Launch Remote Diagnosis (Device-To-PC) .....	38
5.4 FEEDBACK.....	40
5.5 DIAGNOSTIC HISTORY .....	41
<b>6 SPECIAL (RESET) FUNCTION .....</b>	<b>42</b>
6.1 OIL RESET SERVICE .....	42
6.2 ELECTRONIC PARKING BRAKE RESET .....	42
6.3 STEERING ANGLE CALIBRATION .....	43
6.4 ABS BLEEDING.....	43
6.5 TIRE PRESSURE MONITOR SYSTEM RESET .....	43
6.6 GEAR LEARNING.....	43
6.7 IMMO SERVICE .....	43
6.8 INJECTOR CODING .....	44
6.9 BATTERY MAINTENANCE SYSTEM RESET .....	44
6.10 DIESEL PARTICULATE FILTER (DPF) REGENERATION .....	44
6.11 ELECTRONIC THROTTLE POSITION RESET.....	44
6.12 GEARBOX MATCHING.....	44
6.13 AFS (ADAPTIVE FRONT-LIGHTING SYSTEM) RESET .....	45
6.14 SUNROOF INITIALIZATION .....	45
6.15 SUSPENSION CALIBRATION .....	45
<b>7 SMARTLINK DIAG.....</b>	<b>46</b>
7.1 INTRODUCTION .....	46
7.2 PERFORM SMARTLINK REMOTE OPERATION .....	48
7.2.1 Posting remote assistance request.....	48
7.2.2 Connections & operations.....	49
<b>8 SOFTWARE UPDATE .....</b>	<b>52</b>
8.1 UPDATE DIAGNOSTIC SOFTWARE & APP .....	52
8.2 SET FREQUENTLY USED SOFTWARE .....	52
8.3 RENEW SUBSCRIPTION .....	53
<b>9 ADAS .....</b>	<b>54</b>
<b>10 USER INFO.....</b>	<b>56</b>
10.1 MY REPORT .....	56
10.2 VCI.....	57
10.3 VCI MANAGEMENT.....	57
10.4 ACTIVATE VCI .....	57
10.5 FIRMWARE FIX.....	57
10.6 MY NEWS.....	58

10.7 DATA STREAM SAMPLE .....	58
10.8 MY ORDER .....	58
10.9 SUBSCRIPTION RENEWAL CARD .....	58
10.10 PROFILE .....	58
10.11 CHANGE PASSWORD .....	58
10.12 SETTINGS .....	58
10.12.1 Units .....	59
10.12.2 Shop Information .....	59
10.12.3 Printer Set .....	59
10.12.4 Clear Cache.....	61
10.12.5 About .....	61
10.12.6 Diagnostic Software Auto Update .....	61
10.12.7 Login/Logout.....	61
10.13 DIAGNOSTIC SOFTWARE CLEAR .....	61
<b>11 VIDEOSCOPE.....</b>	<b>62</b>
11.1 INTRODUCTION .....	62
11.2 CONNECTIONS & OPERATIONS .....	62
<b>12 J2534 REPROGRAMMING USING SMARTLINK C.....</b>	<b>63</b>
12.1 AS A LOCAL J2534 PASSTHRU DEVICE.....	63
12.2 AS A REMOTE J2534 PASSTHRU DEVICE.....	63
<b>13 SYNCHRONIZATION.....</b>	<b>65</b>
<b>14 FAQ.....</b>	<b>66</b>
14.1 ABOUT X-431 PRO5 .....	66
14.2 ABOUT SMARTLINK DIAG.....	67
<b>15 GLOSSARY OF TERMS &amp; ABBREVIATIONS .....</b>	<b>68</b>

# 1 Introduction

## 1.1 Product Profile

X-431 PRO5 is a powerful Android-based diagnostic tool, which has several production configurations ranging from commercial vehicle to passenger vehicle. It inherits from LAUNCH's advanced diagnosing technology and is characterized by covering a wide range of vehicles, featuring powerful functions, and providing precise test result.

Through the simple Bluetooth or USB communication between the SmartLink C device and the display tablet, it achieves full car model and full system vehicle trouble diagnosis, which include Reading DTCs, Clearing DTCs, Reading Data Stream, Actuation Test and Special Functions. Moreover, taking advantage of the mobile Internet, it also integrates SmartLink (Diagnostic System), Remote Diagnose and Repair Data, which helps to diagnose vehicle issues more efficiently, and greatly increase customer's retention and boost shop revenue.

## 1.2 Features

- **Intelligent Diagnose:** This module allows you to use the VIN information of the currently identified vehicle to access its data (including vehicle information, historical diagnostic records) from the cloud server to perform quick test, eliminating guesswork and step-by-step manual menu selection.
- **Local Diagnose:** Follow the on-screen prompts to start diagnostic session step by step. Diagnosis functions include: Read DTCs, Clear DTCs, Read Data Stream, Special Functions etc.
- **SmartLink Diag.:** A perfect and powerful remote diagnostics solution developed by LAUNCH.  
In this ecology system, if a technician or car owner (SmartLink C) does not have time to puzzle through a touch vehicle problem, he can seek a trusted second opinion or additional expertise on various vehicle issues from remote master technicians or repair shops (SmartLink B). SmartLink B enables the shop owner to greatly increase customer's retention and boost shop revenue by providing the professional technical assistance service.
- **Remote Diagnose:** This helps repair shops or mechanics to diagnose a remote vehicle, and launch instant messages, allowing for improved efficiency and faster repairs.
- **Reset:** All kinds of common maintenance and reset items including Oil lamp reset, ABS bleeding, Steering angle calibration, Tire pressure monitor system reset, Gear learning, Injector coding and DPF regeneration etc. can be done.
- **One-click Update:** Lets you update your diagnostic software online.
- **Diagnostic History:** This function provides a quick access to the tested vehicles and users can choose to view the test report or resume from the last operation, without the necessity of starting from scratch.
- **Feedback:** Enables you to submit the vehicle issue to us for analysis and troubleshooting.
- **Vehicle Coverage:** Quick dial to view the vehicle models that the tool covers.
- **ADAS calibration:** Optional. This function needs to be activated before normal use and only works with the LAUNCH-specific ADAS calibration tool.

## 1.3 Components & Controls

There are two main components to the diagnostic system:

- Display Tablet – the central processor and monitor for the system (See **Chapter 1.3.1**).

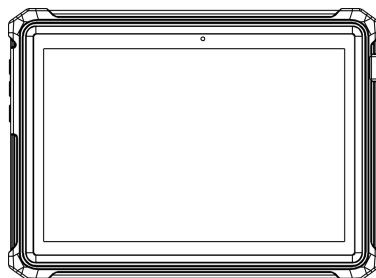

- SmartLink C Device – the device for accessing vehicle data (See **Chapter 1.3.2**).

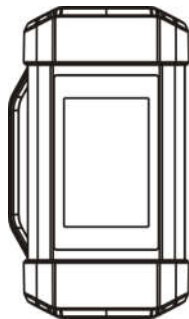

**1.3.1 Display Tablet**

The tablet acts as the central processing system, which is used to receive and analyze the live vehicle data from the SmartLink C device and then output the test result.

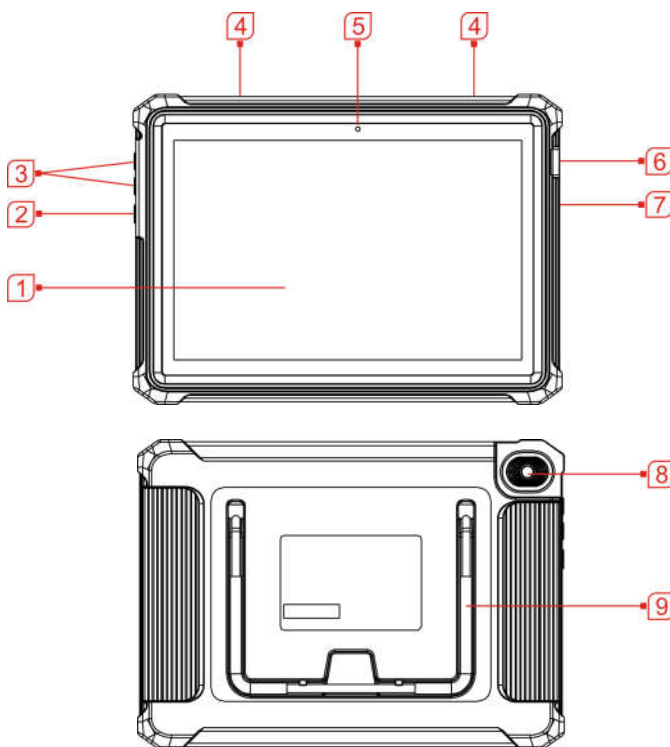

1	<b>LCD Screen</b>	Indicates the test results.
2	<b>POWER Key</b>	<p>In Off mode, press it for 3 seconds to turn the tablet on.                      In On mode:</p> <ul style="list-style-type: none"> <li>• Press it once to activate the LCD if the LCD is off. Press it once to turn off the LCD if the LCD lights up.</li> <li>• Press and hold it for 3 seconds to turn it off.</li> <li>• Press and hold it for 8 seconds to perform forced shutdown.</li> </ul>
3	<b>Volume +/-</b>	Adjusts the system volume.
4	<b>Speakers</b>	



5	<b>Front Camera</b>	
6	<b>Charging / Data I/O Port</b>	<ul style="list-style-type: none"> <li>• Connects to AC outlet for charging.</li> <li>• Connects to PC for data exchange.</li> </ul>
7	<b>Microphone</b>	
8	<b>Rear Camera</b>	
9	<b>Adjustable stand</b>	Flip it out to any angle and work comfortable at your desk, or hang it on steering wheel.

**1.3.2 SmartLink C Device**

The SmartLink C device features powerful functions and it can be applied in the following situations:

- 1). When as a VCI (Vehicle Communication Interface), it needs to work in conjunction with the **Diagnose** module of the tablet, which is used to obtain vehicle data, and then send it to the tablet for analysis via Bluetooth / data cable.

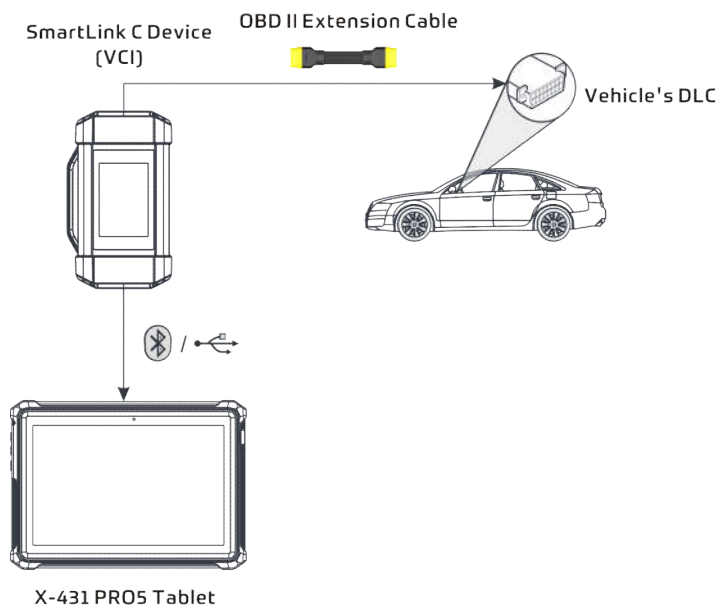

- 2). When as a SmartLink C (Customer) dongle, it does not communicate with the tablet, but it needs to work together with the **SmartLink** module of the tablet. The tablet is mainly used to issue remote diagnostic requests, and the SmartLink C dongle is networked to receive and execute commands from the remote SmartLink B (Business).

\*Note: For detailed operations, please refer to Chapter 7.

- 3). When as a local or remote J2534 PassThru device, it can be used in conjunction with the PC installed with OEM diagnostic software.

\*Note: For detailed operations, please refer to Chapter 12.

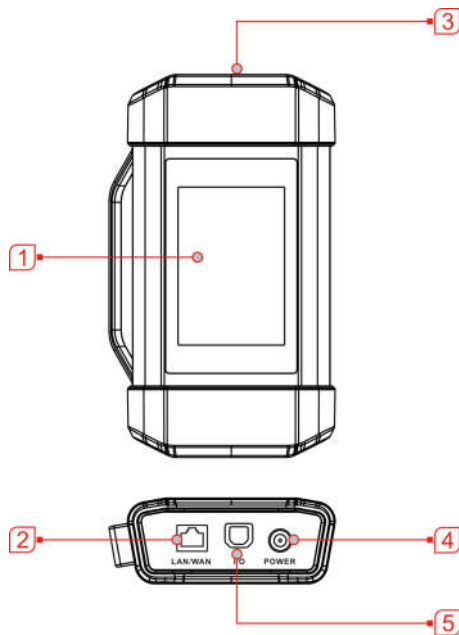

1	<b>Touch Screen</b>	
2	<b>LAN/WAN Port</b>	Connects the SmartLink C device to the Internet via the crossover cable.
3	<b>OBD-16 Diagnostic Connector</b>	Connects the SmartLink C device to the vehicle's DLC (Data Link Connector) port via the OBD II extension cable.
4	<b>DC-IN Port</b>	Currently disabled and for manufacturer use only. <b>*Warning: The SmartLink C device obtains power through the vehicle's DLC, and it is prohibited to connect to an external DC power supply. No responsibility can be assumed for any damage or loss caused as a result of not strictly following the above method.</b>
5	<b>Data I/O Port</b>	Connects the SmartLink C device to the PC via the data cable when as a J2534 PassThru device.

## 1.4 Technical Parameters

### 1.4.1 Display tablet

Operating system	Android
Memory	3GB
Storage	32GB
Screen	10.1 inch FHD IPS capacitive touch screen with a resolution of 1920 x 1200 pixels
Camera	Front-facing 5.0MP + Rear-facing 8.0MP camera
Connectivity	<ul style="list-style-type: none"> <li>• Wi-Fi (802.11a/b/g/n/ac)</li> <li>• Bluetooth</li> </ul>

Working temperature	0°C ~ 50°C
Storage temperature	-20°C ~ 70°C

#### 1.4.2 SmartLink C device

Size	204mm x 110mm x 45mm
Working voltage	DC 9 ~36V
Typical power consumption	≤ 6W
Communication	Bluetooth/Wi-Fi or data cable connection
Working temperature	0°C ~ 50°C

#### 1.5 Package List (Only for Passenger Vehicle Configuration)

Common accessories are same, but for different destinations, the accessories (such as diagnostic software, testing connectors) may vary. Please consult from the local agency or check the package list supplied with this tool together.

No.	Item	Descriptions	Qt.
1	Display tablet	Indicates the test result.	1
2	SmartLink C device		1
3	Power adaptor		1
4	OBD II extension cable	Connects the SmartLink C device to the OBD II vehicle's DLC.	1
5	Charging cable (Type A-Micro)	Charges the tablet.	1
6	Data cable (Type A- Type B)	Connects the SmartLink C device to PC for J2534 reprogramming.	1
7	Crossover cable	Connects the SmartLink C device to the modem.	1
8	OBD I adaptor box	Connects the SmartLink C device and non-16pin adaptor cable.	(Optional)
9	Cigarette lighter cable	Supplies power to the non-16pin connector from the vehicle's cigarette lighter receptacle.	(Optional)
10	Battery clamps cable	Supplies power to the non-16pin connector from the vehicle's battery.	(Optional)
11	Non-16pin adaptor cable kit	Connects to the vehicle equipped with non-OBD II management system.	(Optional)

#### 1.5 Package List (Only for Commercial Vehicle Configuration)

Common accessories are same, but for different destinations, the accessories (such as diagnostic software, testing connectors) may vary. Please consult from the local agency or check the package list supplied with this tool together.

No.	Item	Descriptions	Qt.
1	Display tablet	Indicates the test result.	1
2	SmartLink C device		1
3	Power adaptor		1
4	OBD II extension cable	Connects the SmartLink C device to the OBD II vehicle's DLC.	1
5	Charging cable (Type A-Micro)	Charges the tablet.	1
6	Data cable (Type A- Type B)	Connects the SmartLink C device to PC for J2534 programming.	1
7	Crossover cable	Connects the SmartLink C device to the modem.	
8	Cigarette lighter cable	Supplies power to the non-16pin connector from the vehicle's cigarette lighter receptacle.	(Optional)
9	Battery clamps cable	Supplies power to the non-16pin connector from the vehicle's battery.	(Optional)
10	Non-16pin adaptor cable kit	Connects to the vehicle equipped with non-OBD II management system.	(Optional)

**1.5 Package List (Only for Gasoline & Diesel Configuration)**

Common accessories are same, but for different destinations, the accessories (such as diagnostic software, testing connectors) may vary. Please consult from the local agency or check the package list supplied with this tool together.



No.	Item	Descriptions	Qt.
1	Display tablet	Indicates the test result.	1
2	SmartLink C device		1
3	Power adaptor		1
4	OBD II extension cable	Connects the SmartLink C device to the OBD II vehicle's DLC.	1
5	Charging cable (Type A-Micro)	Charges the tablet.	1
6	Data cable (Type A- Type B)	Connects the SmartLink C device to PC for J2534 programming.	1
7	Crossover cable	Connects the SmartLink C device to the modem.	
8	OBD I adaptor box	Connects the SmartLink C device and non-16pin adaptor cable.	(Optional)
9	Cigarette lighter cable	Supplies power to the non-16pin connector from the vehicle's cigarette lighter receptacle.	(Optional)

10	Battery clamps cable	Supplies power to the non-16pin connector from the vehicle's battery.	(Optional)
11	Non-16pin adaptor cable kit for passenger vehicles	<p>For different vehicle diagnostic socket, it may be necessary to use one of the adaptor cables included within the kit.</p> <p>For detailed non-16pin adaptor cables, please check the package box.</p>	(Optional)
12	Non-16pin adaptor cable kit for commercial vehicles	For detailed non-16pin adaptor cables, please check the package box.	(Optional)

## 2 Preparations

### 2.1 Charging the Tablet

1. Plug one end of the included charging port of the tablet, and the other end to the power adaptor.
2. Connect the other end to the AC outlet.

If  appears on the screen, it indicates it is being charged. If the logo changes into , it indicates that the battery is fully charged. Unplug the power adaptor from the tablet.

### 2.2 Using Battery

- If the battery remains unused for a long period of time or the battery is completely discharged, it is normal that the tool will not power on while being charged. Please charge it for a period of 5 minutes and then turn it on.
- Please use the included power adaptor to charge the tablet. No responsibility can be assumed for any damage or loss caused as a result of using power adaptors other than the one supplied.
- While the tablet has low battery, a beep will sound. If it is very low, the tablet will be switched off automatically.

### 2.3 Power on/off

#### 2.3.1 Power on

Press [POWER] to turn the tool on.

\*Note: If it is the first time you have used this tool or the tool remains idle for a long period of time, the tool could fail to turn on. Please charge the tool for a minimum of 5 minutes and attempt to turn on again.

#### 2.3.2 Power off

Press [POWER] for 3 seconds, an option menu will pop up on the screen. Tap **Power off** to turn the tool off.

### 2.4 Tips on Finger Operations



**Single-tap:** To select an item or launch a program.



**Double-tap:** To zoom in so that the text on a webpage appears in a column that fits your device's screen.



**Long press:** Tap and hold on the current interface or area until a contextual menu pops up on the screen, and then release it.



**Slide:** To jump to different pages.



**Drag:** Tap the application icon and drop it to other location.



**Spread apart/pinch together:** To zoom in manually, place two fingers on the screen and then spread them apart. To zoom out, place two fingers apart on the screen and then pinch them together.

### 2.5 Screen Layout

The following on-screen buttons are available on the bottom of the screen.



Tap it to return to the previous screen.

**HOME**

Tap it to navigate to the Android's home screen.

**Recent Apps**

Tap it to view the recently launched applications.

**Screenshot**

Tap it to capture the current screen.

## 2.6 Adjust Brightness

 **Tips:** Reducing the brightness of the screen is helpful to conserve the battery power.

1. On the home screen, tap **Settings -> Display -> Brightness level**.
2. Drag the slider to adjust it.

## 2.7 Change System Language

The tool supports multiple system languages. To change the language of the tool, please do the following:

1. On the home screen, tap **Settings -> System -> Language & input -> Languages**.
2. Tap **Add a language**, and then choose the desired language from the list.
3. Tap and hold the desired language and drag it to the top of the screen and then release it, the system will change into the target language.

## 2.8 Set Standby Time

If no activities are made within the defined standby period, the screen will be locked automatically and the system enters sleep mode to save power.

1. On the home screen, tap **Settings -> Display -> Advanced -> Sleep**.
2. Choose the desired sleep time.

## 3 Network Setup

The tablet has built-in WLAN module that can be used to get online. Once you're online, you can register the tool, surf the Internet, send email, launch the remote diagnosis, and check for software updates etc.

### 3.1 Connect to a WLAN Network

1. On the home screen, tap **Settings -> Network & Internet -> WLAN**.
2. Slide the WLAN switch to ON, the tablet starts searching for available wireless networks.
3. Select a wireless network,
  - If the chosen network is open, the tablet will connect automatically.
  - If the selected network is encrypted, a network password will need to be entered.
4. When **Connected** appears, it indicates the WLAN connection is complete.

\*Note: When Wi-Fi is not required, this should be disabled to conserve battery power.

Once it is connected successfully, tap the desired network from the list to view its name, link speed, security type, IP address etc.

When this tool is in range, it will connect to the previously linked network automatically.

### 3.2 Disconnect From a WLAN Network

1. On the home screen, tap **Settings -> Network & Internet -> WLAN**.
2. Tap the network with a Connected status, then tap **Disconnect**.



## 4 Initial Use

### 4.1 Diagnosis Flowchart

For new users, please follow the operation chart shown as below to get familiar with and start using this tool.

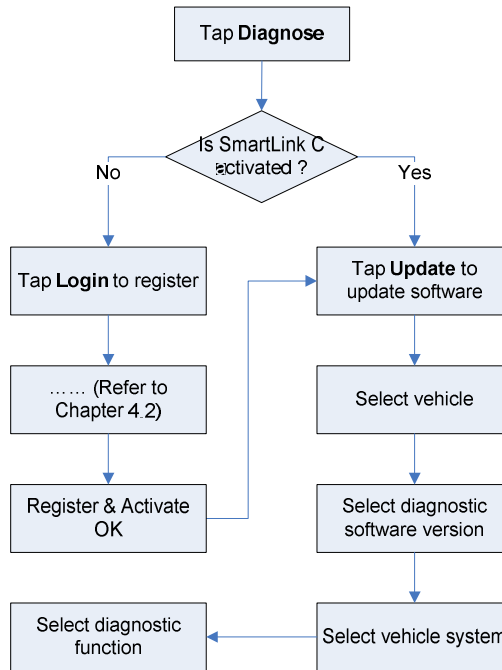

## 4.2 Getting Started

### 4.2.1 Register & Update

For initial use, the registration is the necessary first procedure to activate the tool.

Tap the application icon on the home screen to launch it, and then tap **Login** on the upper right corner of the screen to enter the following screen.

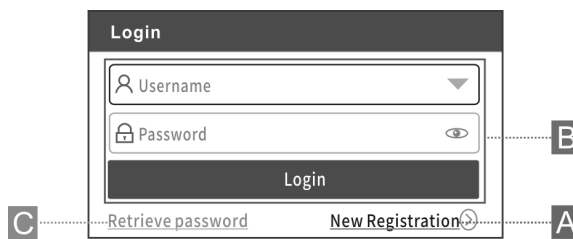

(If you are a new user, follow **A** to proceed.)

(If you have registered to be a member, go to **B** to login the system directly.)

(In case you forgot password, refer to **C** to reset a new password.)

**A.** If you are a new user, tap **New Registration** to enter the sign-up page.

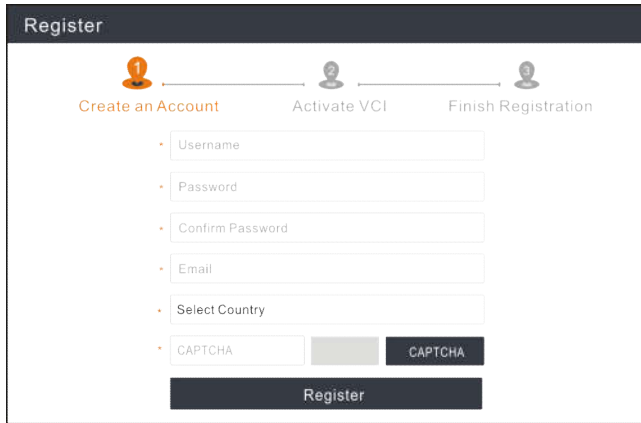

In the above figure, fill in the information in each field (Items with \* must be filled). After inputting, tap **Register**, a screen similar to the following will appear:

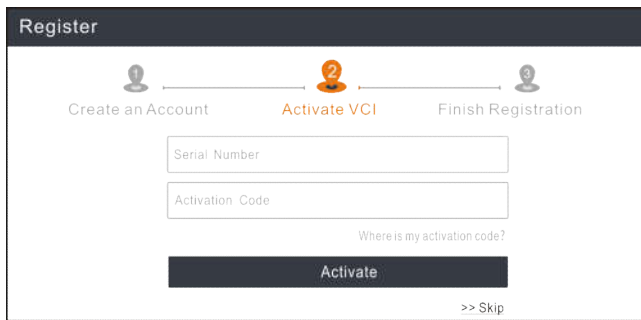

Input the Serial Number and Activation Code, which can be found in the Password Envelope.

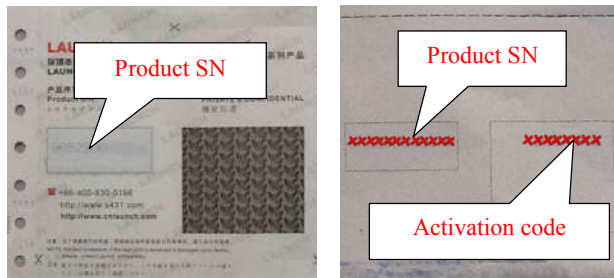

\*Note: To exit and activate it later, tap **Skip**. In this case, please activate the VCI module by tapping **User Info** -> **Activate VCI**. For details, please refer to Chapter 10.4 Activate VCI.

Tap **Activate** to finish your registration.

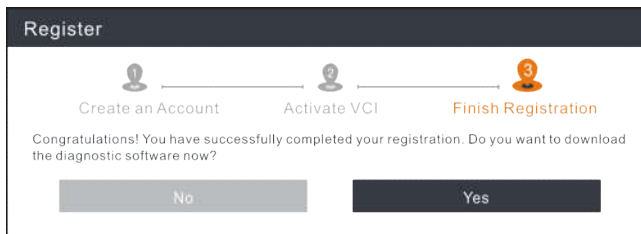

To download the diagnostic software, tap **Yes** to enter the update page.

Tap **No** to download and install it later in the Software Update.

On the download screen, tap **Update** to start downloading. To pause downloading, tap **Stop**. To resume it, tap **Continue**.

Once download is complete, the system will install the software package automatically.

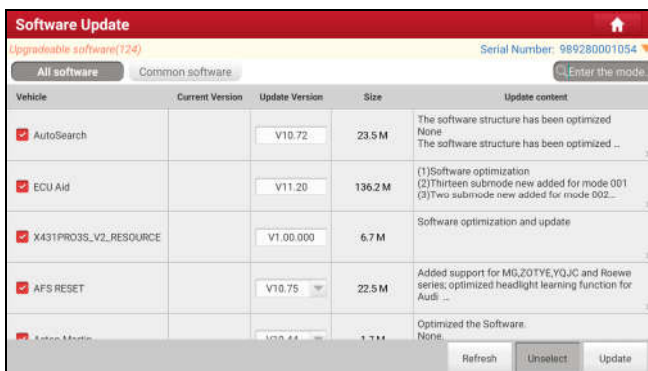

\*Note: In process of download, please make sure it is properly connected to the WLAN network. It may take several minutes to finish it, please be patient to wait.

**B. If you have registered to be a member,** input your name and password, and then tap the **Login** button to enter the main menu screen directly.

\*Note: After the username and password are entered the first time, the system’s auto-save function automatically stores it. After initial setup it is no longer necessary to input the account information automatically to log in.

**C. If you forgot the password,** tap **Retrieve password** and then follow on-screen instructions to set a new password.

**4.2.2 Job menu**

After logging in, the **Login** button will change into the  button. It mainly includes the following items:



Name	Description
<b>Intelligent Diagnose</b>	This module allows you to obtain vehicle data from the cloud server to perform quick test via reading VIN, which provides a perfect solution to various defects resulting from step-by-step menu selection. In addition, user can also check the historical repair records online through this module.
<b>Local Diagnose</b>	To diagnose a vehicle manually.
<b>Reset</b>	To perform all kinds of common repair & maintenance items, including oil lamp reset, electronic parking brake reset, steering angle calibration, ABS bleeding, tire pressure monitor system reset, gear learning, IMMO service, injector coding, battery maintenance system reset, diesel particulate filter regeneration, gearbox matching, and electronic throttle position reset etc.
<b>SmartLink</b>	The SmartLink system is powerful remote diagnostics solution developed by LAUNCH. The system consists of SmartLink C dongle, SmartLink Service Platform and SmartLink B dongle. <ul style="list-style-type: none"> <li>• <u>SmartLink C dongle</u>: For technicians seeking technical assistance and additional expertise on various vehicle issues.</li> <li>• <u>SmartLink Service Platform</u>: For SmartLink C posting assistance request and SmartLink B accepting order.</li> <li>• <u>SmartLink B dongle</u>: For service provider or master technician providing technical assistance service.</li> </ul>
<b>Software Update</b>	To update vehicle diagnostic software and APK.
<b>Diagnostic History</b>	When a vehicle diagnosis is performed, the tablet records the detailed diagnostic information. The History function allows access to previously tested vehicle records.

	Testing can be resumed from the previous operation without starting from scratch.
<b>Remote Diagnose</b>	This helps repair shops or mechanics to diagnose a remote vehicle, and launch instant messages, allowing for improved efficiency and faster repairs.
<b>Feedback</b>	To feed back the recent 20 diagnostic logs to us for issue analysis.
<b>ADAS</b>	This function enables users to perform ADAS (Advanced Driver Assistance System) calibration operations. The ADAS calibration software is disabled by default. Before using this function, users must activate the ADAS function using the ADAS Activation Card.
<b>Mail</b>	An online diagnostic software store. This module enables you to subscribe some extra software or service functions that are not integrated in the tool online.
<b>Vehicle Coverage</b>	To view all the vehicle models that the tool covers.
<b>Maintenance</b>	Abundant maintenance data are available, which helps repair professionals diagnose and repair vehicles efficiently, accurately and profitably.
<b>User Info</b>	To manage VCI, my reports, change password, configure Wi-Fi printer, system settings and logout etc.
<b>Other Modules</b>	Includes Videoscope, product manual, FAQ and some system Apps etc.

### 4.2.3 Diagnostics toolbar

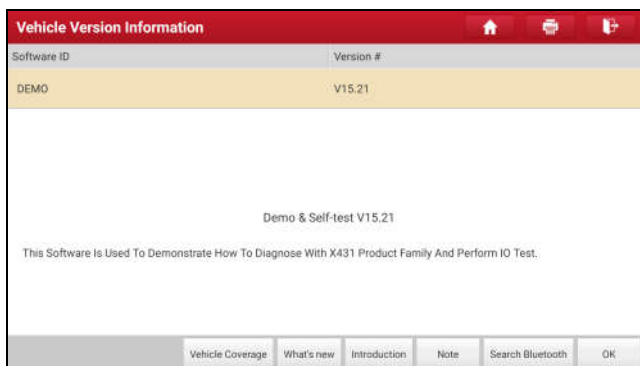
The diagnostics toolbar contains a number of buttons that allow you to print the displayed data or make other controls. It is displayed on the upper right corner of the screen and goes through the whole diagnostic session. The table below provides a brief description for the operations of the diagnostics toolbar buttons:



Name	Button	Description
Home		Returns to Job menu screen.
Print		Touch to print the selected screenshots out via external printer. The printer needs to be configured separately. For details on printer setting, refer to Chapter 10.12.3.
Exit		To exit the diagnostic application.

## 4.3 Connections

### 4.3.1 Preparation

#### Normal testing conditions

- The ignition is turned on.
- The vehicle battery voltage range is 9-14V or 18-30V.
- The throttle is in closed position.

**4.3.2 DLC location**

For passenger cars, the DLC (Data Link Connector) is typically a standard 16-pin connector where diagnostic code readers interface with the vehicle’s on-board computer. The DLC is usually located 12 inches from the center of the instrument panel (dash), under or around the driver’s side for most vehicles. If DLC is not located under dashboard, a label should be there telling location. For some Asian and European vehicles, the DLC is located behind the ashtray and the ashtray must be removed to access the connector. If the DLC cannot be found, refer to the vehicle’s service manual for the location.

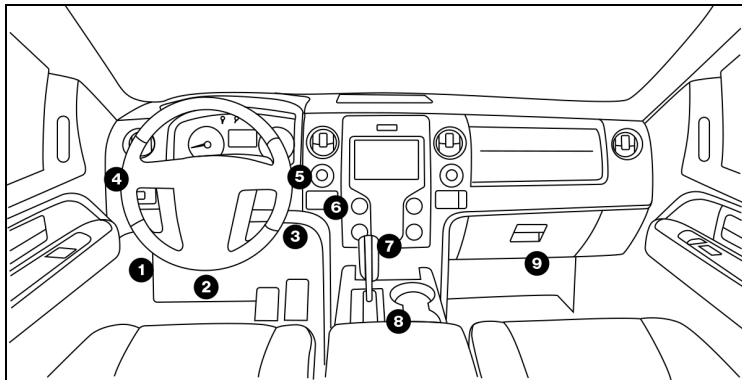

For commercial vehicles, the DLC is always located in driver’s cab.

**4.3.3 Vehicle connection (For Passenger Vehicle Configuration)**

The method used to connect the VCI device to a vehicle’s DLC depends on the vehicle’s configuration as follows:

- A vehicle equipped with an OBD II management system supplies both communication and 12V power through a standardized DLC.
- A vehicle not equipped with an OBD II management system supplies communication through a DLC connection, and in some cases supplies 12V power through the cigarette lighter receptacle or a connection to the vehicle battery.

For OBD II vehicles, connect the SmartLink C to vehicle’s DLC directly via the OBD II extension cable.



For non-OBDII vehicles, proceed as follows:

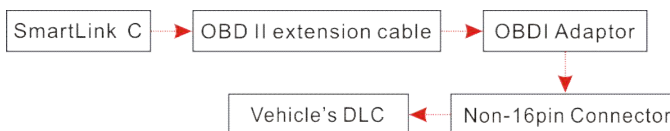

\*Note: If the power supply on vehicle diagnostic socket is insufficient or the power pin is damaged, you can get power via either of the following ways:

- Via Battery clamps cable (optional): Connect one end of the battery clamps cable to the power jack of the OBD I adaptor box, and the other end to the vehicle’s battery.

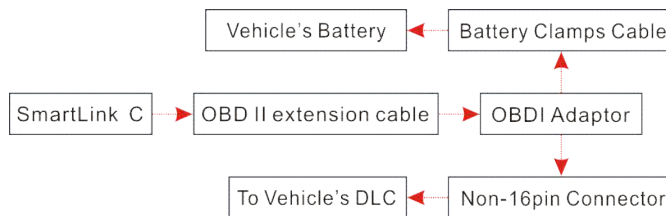

B. Via Cigarette lighter cable (optional): Connect one end of the cigarette lighter cable to the power jack of the OBD I adaptor box, and the other end to the cigarette lighter receptacle.

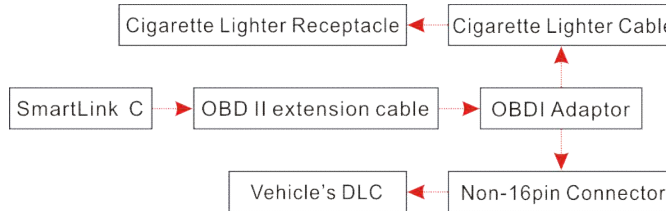

**4.3.3 Vehicle connection (For Commercial Vehicle/Gasoline & Diesel Vehicle Edition)**

The method used to connect the VCI module to a vehicle's DLC depends on the vehicle's configuration as follows:

For OBD II vehicles, connect the SmartLink C to vehicle's DLC directly via the OBD II extension cable.



For non-OBDII vehicles, proceed as follows:

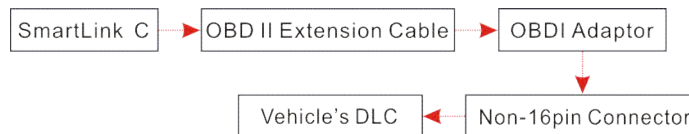

(For Passenger Cars)

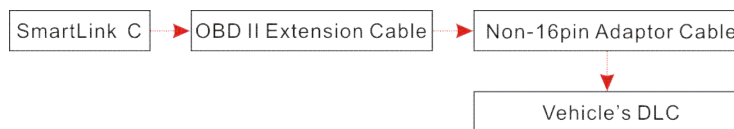

(For Commercial Vehicles)

**4.4 Diagnostic Trouble Codes (DTCs)**

OBD II Diagnostic Trouble Codes are codes that are stored by the on-board computer diagnostic system in response to a problem found in the vehicle. These codes identify a particular problem area and are intended to provide you with a guide as to where a fault might be occurring within a vehicle. **DO NOT** replace parts based only on DTCs without first consulting the vehicle's service manual for proper testing procedures for that particular system, circuit or component.

OBD II Diagnostic Trouble Codes consist of a five-digit alphanumeric code.

- The 1st character is a **letter** (B, C, P or U). It identifies the "main system" where the fault occurred (Body, Chassis, Powertrain, or Network).
- The 2nd character is a **numeric digit** (0 thru 3). It identifies the "type" of code (Generic or Manufacturer-Specific).

Notes:

- Generic DTCs are codes that are used by all vehicle manufacturers. The standards for generic DTCs, as well as their definitions, are set by the Society of Automotive Engineers (SAE).

- Manufacturer-Specific DTCs are codes that are controlled by the vehicle manufacturers. The Federal Government does not require vehicle manufacturers to go beyond the standardized generic DTCs in order to comply with the new OBD II emissions standards. However, manufacturers are free to expand beyond the standardized codes to make their systems easier to diagnose.
- The 3rd character is a letter or a numeric digit (0 thru 9, A thru F). It identifies the specific system or sub-system where the problem is located.
- The 4th and 5th characters are letters or numeric digits (0 thru 9, A thru F). They identify the section of the system that is malfunctioning.

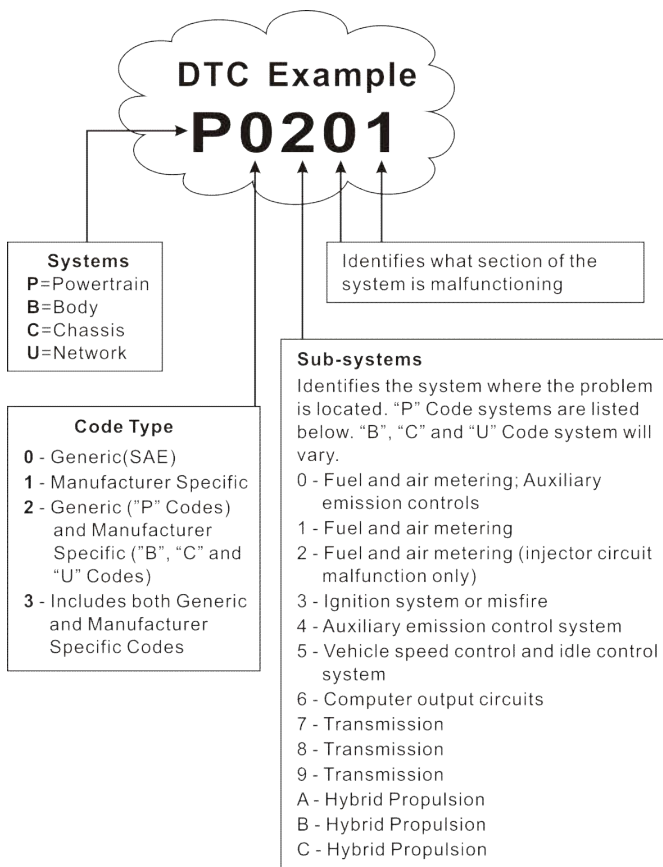

P0201 - Injector circuit malfunction, Cylinder 1

## 5 Diagnosis

### 5.1 Intelligent Diagnose

Through simple Bluetooth communication between the display tablet and SmartLink C device, you can easily get the VIN (Vehicle Identification Number) information of the currently identified vehicle. Once the VIN is successfully identified, the system will retrieve it from the remote server and then guide you to vehicle information page without the necessity of step-by-step manual menu selection.

The vehicle information page lists all historical diagnostic records of the vehicle, which lets the technician have a total command of the vehicle faults. In addition, a quick dial to local diagnose and diagnostic function are also available on this page for reducing the roundabout time and increasing productivity.

\*Notes:

- Before using this function, please make sure the VCI is properly connected to the vehicle's DLC. For detailed connection, see Chapter 4.3.3 **Vehicle Connection**.
- A stable network connection is required for this function.

Follow the steps below to proceed.

1. Tap **Intelligent Diagnose** on the Job menu screen.

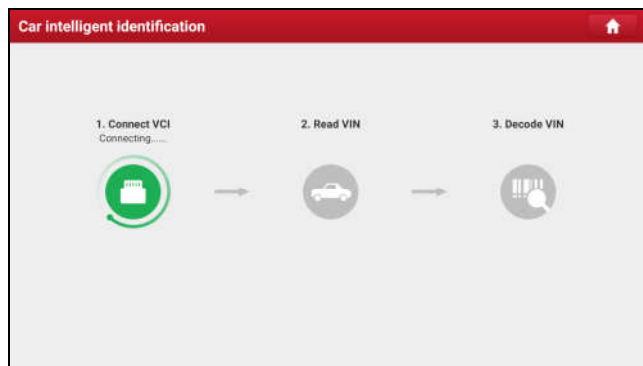

Note: If the VCI is not paired up with the tablet before doing this step, a prompt message box will appear on the screen. Check all the possible reasons of Bluetooth connection failure carefully, and then tap **OK** to the following screen.

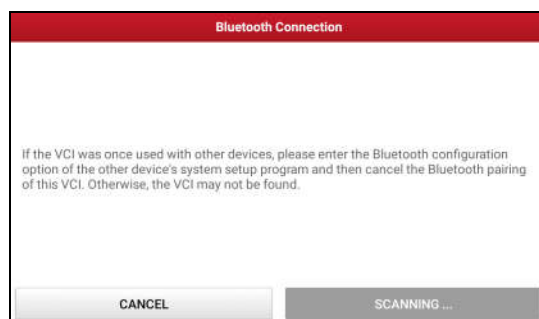

If the VCI was once used with other devices, you need to cancel the pairing of the VCI first via either one of the following ways:

- On the Android's home screen, tap **Settings** -> **Connected devices** -> **Previously connected devices** -> Choose the desired VCI from the Paired list. Tap , and then tap **FORGET** to unpair it.
- Tap **User Info** -> **VCI Management** -> Tap **Deactivate matching**.

Tap **Scan** to start searching for the VCI and pairing up with it.

2. Once pairing is complete, the handset starts reading the vehicle VIN.



A. If the VIN can be found from the remote server database, the following screen will appear:

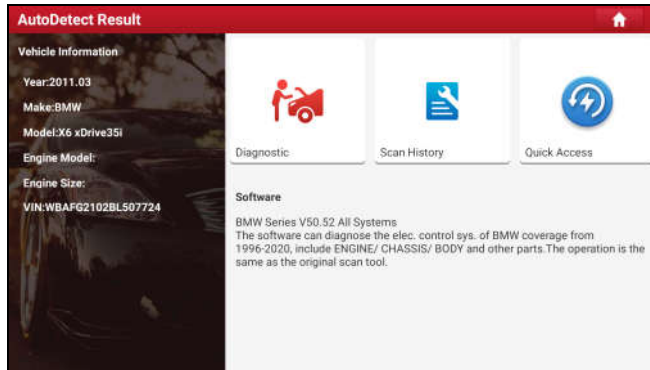



- Tap **Diagnostic** to start a new diagnostic session.
- To perform other functions, tap **Quick access** to directly go to the diagnostic function selection screen. Choose the desired one to start a new diagnostic session.
- Tap **Scan History** to view its historical repair record. If there are records available, it will be listed on the screen in sequence of date. If no records exist, the screen will show “No Record.”

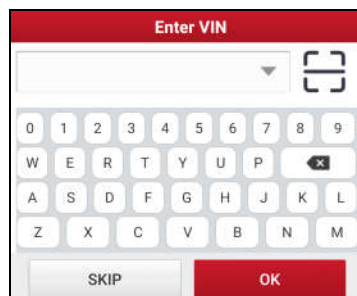

- Tap **View record** to view the details of the current diagnostic report.
- To perform other functions, tap **Quick access** to directly go to the diagnostic function selection screen. Choose the desired one to start a new diagnostic session.

B. If the handset failed to access the VIN information, the screen will display as below:



- Tap the input field to directly, tap **OK**. If the VIN exists on the remote server, the system will enter the diagnostic function selection screen.
- Tap  to launch the VIN recognition module.

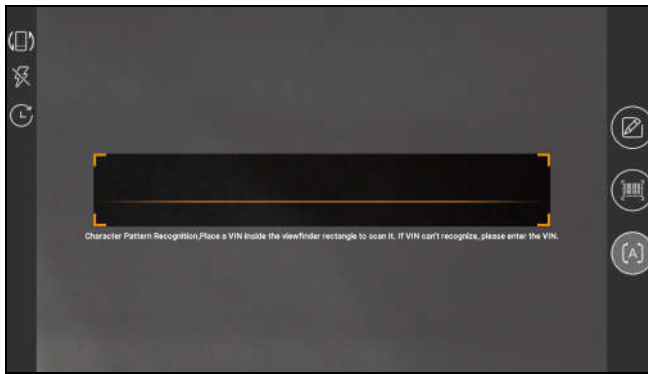

Place the VIN inside the viewfinder rectangle to scan it. The most recognizable location for this number is in the top left corner on the vehicle's dashboard. Other locations include the driver's door or post, and the firewall under the hood.

- Tap to switch the display mode of the screen.
- Tap to turn the camera flash on.
- Tap to choose it from the record list if the VIN of the vehicle has been scanned before.
- Tap to input the VIN manually if the tablet has failed to identify the VIN of the vehicle.
- Tap to scan the VIN barcode. If the VIN barcode cannot be recognized, please manually input the VIN.
- Tap to scan the VIN character. If the VIN character cannot be recognized, please manually input the VIN.

\*Note: In general, vehicle identification numbers are standardized - all contain 17 characters. VIN characters may be capital letters A through Z and numbers 1 through 0; however, the letters I, O and Q are never used in order to avoid mistakes of misreading. No signs or spaces are allowed in the VIN.

After scanning, the screen automatically displays the result.

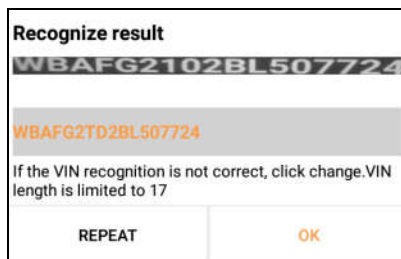

- If the VIN scanned is incorrect, tap the result field to modify it and then tap **OK**.
- To scan it again, tap **REPEAT**.

If the VIN exists on the remote server, the system will enter the diagnostic function selection screen.

## 5.2 Local Diagnose

In this mode, you need to execute the menu-driven command and then follow the on-screen instruction to proceed. Tap **Local Diagnose** to enter the vehicle selection page.

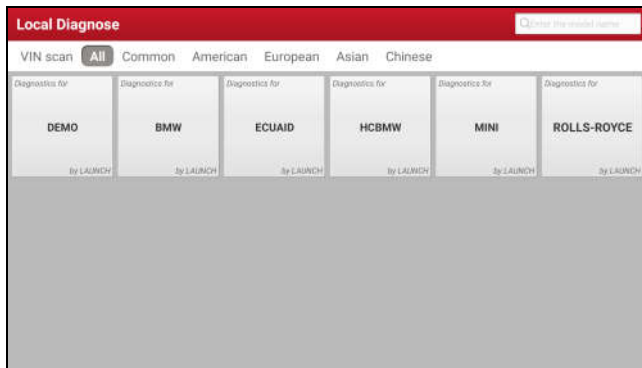

2 approaches are provided for you to access the vehicle diagnostic software. Choose any one of the following ways:

1. VINSCAN enables you to access it more quickly.

Tap **VINScan**, the screen displays as follows:

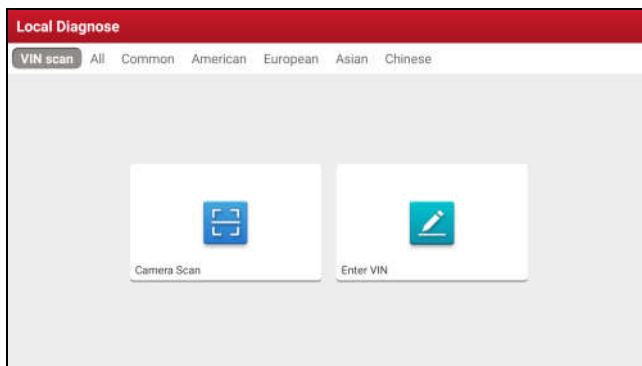



In this case, camera scan and enter VIN are available.



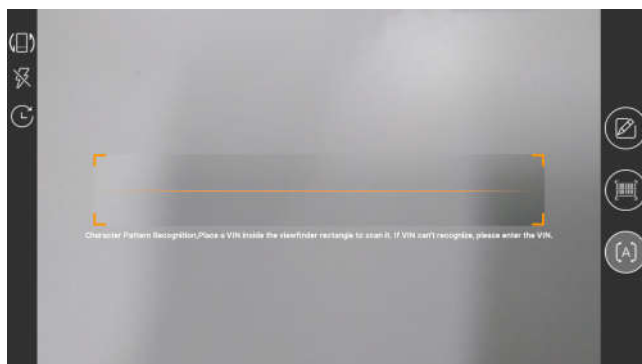

A. Camera Scan: In this mode, the VCI should be connected to the vehicle's DLC first, and then a Bluetooth communication should be established between the tablet and the VCI.

Tap **Camera Scan**, a screen similar to the following appears:



Place the VIN inside the viewfinder rectangle to scan it. The most recognizable location for this number is in the top left corner on the vehicle's dashboard. Other locations include the driver's door or post, and the firewall under the hood.

- Tap  to switch the display mode of the screen.
- Tap  to turn the camera flash on.

- Tap  to choose it from the record list if the VIN of the vehicle has been scanned before.
- Tap  to input the VIN manually if the tablet has failed to identify the VIN of the vehicle.
- Tap  to scan the VIN barcode. If the VIN barcode cannot be recognized, please manually input the VIN.
- Tap  to scan the VIN character. If the VIN character cannot be recognized, please manually input the VIN.

\*Note: In general, vehicle identification numbers are standardized - all contain 17 characters. VIN characters may be capital letters A through Z and numbers 1 through 0; however, the letters I, O and Q are never used in order to avoid mistakes of misreading. No signs or spaces are allowed in the VIN.

After scanning, the following screen will appear.

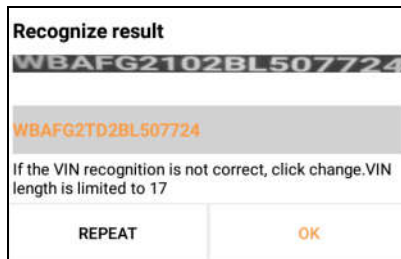

If the VIN scanned is incorrect, tap the result field to modify it and then tap **OK**. If the VIN exists on the remote server, the system will navigate to the diagnostic function selection screen directly.

Tap the desired option to perform the corresponding diagnostic function.

\*Note: Before using this function, the corresponding diagnostic software and Auto search file need to be downloaded on your tool first while downloading the diagnostic software.

**B. INPUT VIN:** In this mode, you can input the vehicle VIN manually. In general, the vehicle identification numbers are standardized - all contain 17 characters. VIN characters may be capital letters A through Z and numbers 1 through 0; however, the letters I, O and Q are never used in order to avoid mistakes of misreading. No signs or spaces are allowed in the VIN.

Tap **Enter VIN**, the following screen will appear.

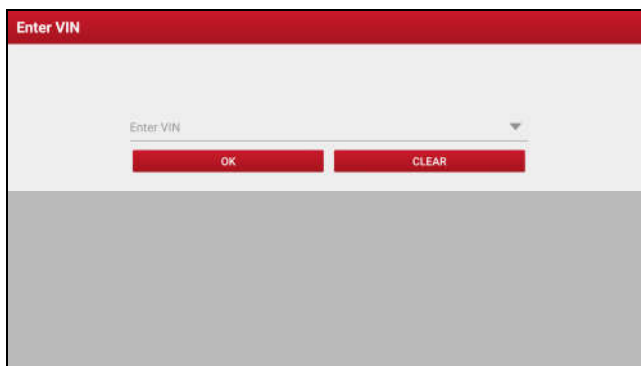

Input the VIN, and tap **OK**, the tablet will automatically identify the vehicle model and directly navigate to the diagnostic function selection menu.

2. Tap a corresponding diagnostic software logo, and then follow the on-screen instruction to access the diagnostic software.

Take Demo as an example to demonstrate how to diagnose a vehicle.

1). **Select diagnostic software version:** Tap the **DEMO** to go to Step 2. (Note: If more than one version is available on this handset, it will be listed on the screen.)

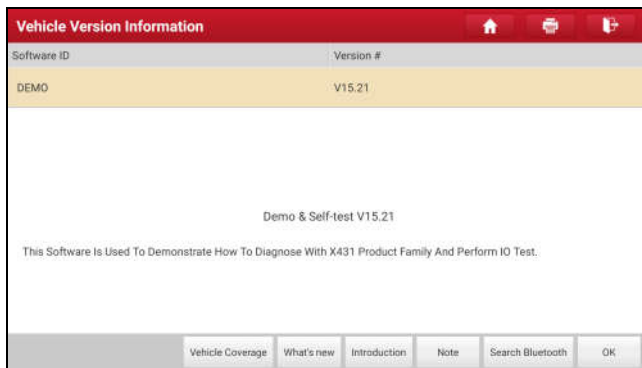

**On-screen Buttons:**

**Vehicle Coverage:** Tap to view the vehicle models that the current diagnostic software covers.

**What's new:** Tap to view the optimized items and enhancements.

**Introduction:** Tap to check the software function list.

**Note:** Tap to read some precautions on using the current diagnostic software.

**Search Bluetooth:** Tap to search for the available VCI. After the VCI is successfully activated, it will be bound to the user account and paired with the tablet automatically.

\*Note: No Bluetooth connection is required for DEMO program.

**OK:** Tap it to go to next step.

2). **Select vehicle model (varies with different versions):** Select the desired vehicle model. Here we take **Ford** for example to demonstrate how to diagnose a vehicle.

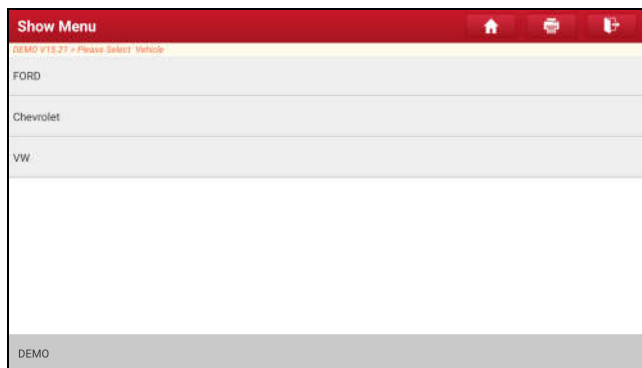

3). **Read vehicle information:** After reading the vehicle information, double check if the vehicle information is correct or not. If yes, tap **Yes** to continue.

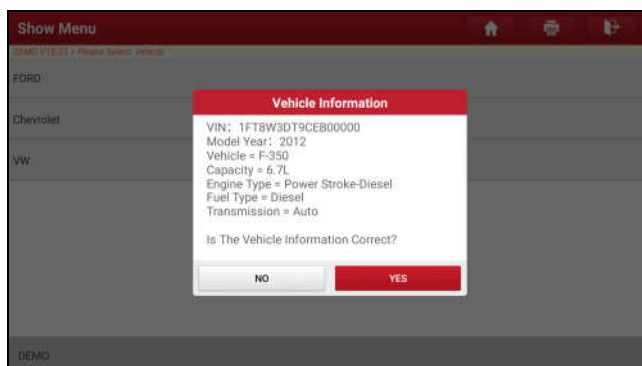

4). Select test item: Select the desired test item to proceed.



5). Turn the ignition key to ON: Set the ignition switch to on.

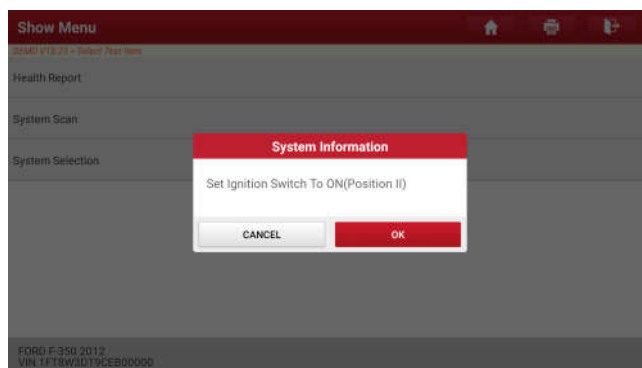

### 5.2.1 Health Report (Quick Test)

This function varies from vehicle to vehicle. It enables you to quickly access all the electronic control units of the vehicle and generate a detailed report about vehicle health.

On the test item selection screen, tap **Health Report** and turn on the ignition switch, the system will start scanning the ECUs. Once the scanning process is complete, the following screen will appear:

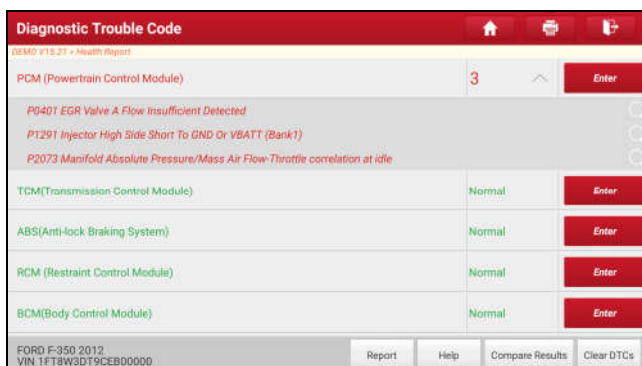

The tested system with fault code appears in red and the system with OK displays in black (normally).

\*Note: Diagnostic Trouble Codes or Fault Codes can be used to identify which engine systems or components that are malfunctioning. Never replace a part based only on the DTC definition. Retrieving and using DTCs for troubleshooting vehicle operation is only one part of an overall diagnostic strategy. Follow testing procedures (in vehicle's service manual), instructions and flowcharts to confirm the locations of the problem.

#### On-screen Buttons:

**Enter:** Tap to enter the diagnostic function selection screen.

**(Search):** Highlight certain diagnostic trouble code and tap it to retrieve it in the search engine.

**Report:** Tap to save the diagnostic result as a health report.

\*Note: Diagnostic report is classified into three categories: Pre-Repair report, Post-Repair report and Diagnostic Scan. No matter which type you saved the report as, the report type will be appended as a tag on the upper right corner of the diagnostic report for easier identification.

Tap ▼ to select the report type from the option list and input the required information, and then tap **OK**.

\*Note: To facilitate the comparison of the pre-repair and post-repair reports and get accurate test result, please make sure you saved the right type of the diagnostic report.

To save the report as a common diagnostic report, select **Diagnostic Scan**.

\*Note: For workshop information, tap the input box to enter it. Alternatively you can also set it in **User Info -> Settings -> Shop Information**.

Once you configured the information, it will be automatically generated every time you saved the diagnostic report. All vehicle and workshop information will be appended as tags on the diagnostic report.

To ignore the workshop information, tap **Skip** to go to the report details screen.



On the report details screen, tap **Save** to save it. All diagnostic reports are saved in **User Info -> My Report -> Health Report**.

**Help:** Tap to view the help information of the selected DTC item.

**Compare Results:** Tap to select the pre-repair report to compare. By comparison of the pre- and post- repair reports, you can easily identify which DTCs are cleared and which remain unfixed.

DTC	Post	Pre
<b>PCM (Powertrain Control Module)</b>		
P0401 EGR Valve A Flow Insufficient Detected	Cleared	Found
P1291 Injector High Side Short To GND Or VBATT (Bank1)	Cleared	Found
P2073 Manifold Absolute Pressure/Mass Air Flow-Throttle correlation at idle	Cleared	Found

- **Post** indicates DTC status of post-repair.
- **Pre** indicates DTC status of pre-repair.

\*Note: Before performing this function, please make sure that:

- You have saved a pre-repair report of the currently tested vehicle, and
- You have already made some repairs and service and cleared the DTCs after the pre-repair reported is generated. Otherwise, no differences exist between the pre- and post- repair reports.

**Clear DTCs:** Tap to clear the existing diagnostic trouble codes.

\*Note: Clearing DTCs does not fix the problem(s) that caused the code(s) to be set. If proper repairs to correct the problem that caused the code(s) to be set are not made, the code(s) will appear again and the check engine light will illuminate as soon as the problem that cause the DTC to set manifests itself.

### 5.2.2 System Scan

This option allows you to quickly scan which systems are installed on the vehicle.

On the test item selection screen, tap **System Scan**, the system start scanning the systems. Once the scanning process is complete, the following screen will appear.



System Name	Result
PCM (Powertrain Control Module)	Equipped
TCM(Transmission Control Module)	Equipped
ABS(Anti-lock Braking System)	Equipped
RCM (Restraint Control Module)	Equipped
BCM(Body Control Module)	Equipped
IMMO(Immobilizer)	Equipped
APIM (Accessory Protocol Interface Module)	Equipped
PAM (Parking Assist Module)	Equipped

FORD F-350 2012  
VIN 1FT8W3D79CEB00000

Tap the desired system to go to the diagnostic function selection screen. For detailed operations on diagnostic function, please refer to Chapter 5.2.3.

### 5.2.3 System Selection

This option allows you to manually select the test system and function step by step.

On the test item selection screen, tap **System Selection**, the screen displays as follows:

PCM (Powertrain Control Module)	TCM(Transmission Control Module)
ABS(Anti-lock Braking System)	RCM (Restraint Control Module)
BCM(Body Control Module)	IMMO(Immobilizer)
APIM (Accessory Protocol Interface Module)	PAM (Parking Assist Module)
ICM1 (Information Center Module)	DDM (Driver Door Module)
DSM (Driver Seat Module)	DSP (Digital Signal Processor)
IPC (Instrument Panel Control Module)	FCIM (Front Controls Interface Module)

FORD F-350 2012  
VIN 1FT8W3D79CEB00000

Swipe the screen from the bottom to view the vehicle system on the next page.

Tap the target system (take **ECM** for example) to navigate to the diagnostic function selection screen.

Version Information	Read Fault Code
Clear Fault Code	Read Data Stream
Actuation Test	Special Function
Program	

FORD F-350 2012  
VIN 1FT8W3D79CEB00000

Note: Different vehicle has different diagnostic menus.

#### A. Version Information

This function is used to read the version information of system mode, vehicle VIN, software and ECU.

#### B. Read Fault Code

This function displays the detailed information of DTC records retrieved from the vehicle's control system.

\*Note: Retrieving and using DTCs for troubleshooting vehicle operation is only one part of an overall diagnostic strategy.

Never replace a part based only on the DTC definition. Each DTC has a set of testing procedures, instructions and flow charts that must be followed to confirm the location of the problem. This information can be found in the vehicle’s service manual.

On the diagnostic function selection screen, tap **Read Fault Code**, the screen will display the diagnostic result.

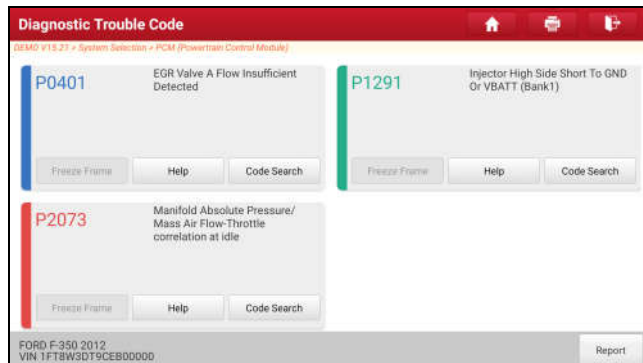

**On-screen Buttons:**

**Freeze Frame:** When an emission-related fault occurs, certain vehicle conditions are recorded by the on-board computer. This information is referred to as freeze frame data. Freeze frame data includes a snapshot of critical parameter values at the time the DTC is set.

**Help:** Tap to view the help information.

**Code Search:** Tap to search for more information about the current DTC online.

**Report:** Tap to save the current data in text format. All reports are saved in **User Info -> My Report -> Health Reports**. For details on report operations, please refer to Chapter 10.1 **My Report**.

**C. Clear Fault Code**

This function enables you to erase the codes from the vehicle after reading the retrieved codes from the vehicle and certain repairs have been carried out. Before performing this function, make sure the vehicle’s ignition key is in the ON position with the engine off.

Clearing DTCs does not fix the problem(s) that caused the code(s) to be set. If proper repairs to correct the problem that caused the code(s) to be set are not made, the code(s) will appear again and the check engine light will illuminate as soon as the problem that cause the DTC to set manifests itself.

On the diagnostic function selection screen, tap **Clear Fault Code**, the following screen will appear.

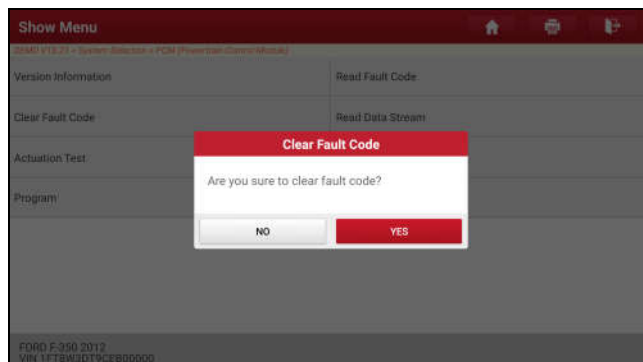

Tap **YES**, the system will automatically delete the currently existing trouble code.

\*Note: After clearing, you should retrieve trouble codes once more or turn ignition on and retrieve codes again. If there are still some trouble codes in the system, please troubleshoot the code using a factory diagnosis guide, then clear the code and recheck.

**D. Read Data Stream**

This option lets you view and capture (record) real-time Live Data. This data including current operating status for parameters and/or sensor information can provide insight on overall vehicle performance. It can also be used to guide vehicle repair.

\*Notes:

- If you must drive the vehicle in order to perform a troubleshooting procedure, ALWAYS have a second person help you. Trying to drive and operate the diagnostic tool at the same time is dangerous, and could cause a serious traffic accident.
- The real time (Live Data) vehicle operating information (values/status) that the on-board computer supplies to the tool for each sensor, actuator, switch, etc. is called Parameter Identification Data (PID).

On the diagnostic function selection screen, tap **Read Data Stream**, the following screen will appear.

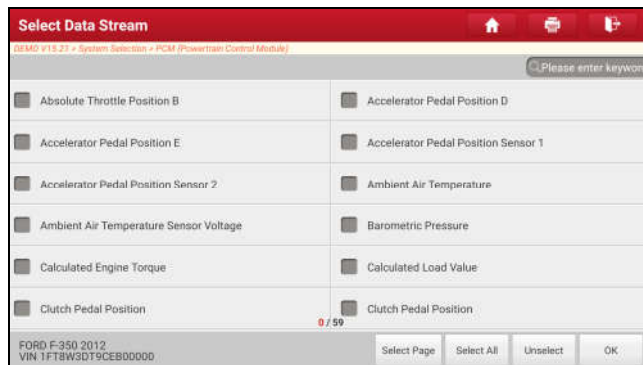

**On-screen Buttons:**

**Select Page:** Tap to select all items of the current page.

**Select All:** Tap to select all items. To select certain data stream item, just check the box before the item name.

**Unselect:** Tap to deselect all data stream items.

**OK:** Tap to confirm and jump to the next step.

After selecting the desired items, tap **OK** to enter the data stream reading page.



\*Notes:

1. If the value of the data stream item is out of the range of the standard (reference) value, the whole line will display in red. If it complies with the reference value, it displays in blue (normal mode).
2. The indicator 1/X shown on the bottom of the screen stands for the current page/total page number. Swipe the screen from the right/left to advance/return to the next/previous page.

There are 3 types of display modes available for data viewing, allowing you to view various types of parameters in the most suitable way.

- ✓ **Value** – This is the default mode which displays the parameters in texts and shows in list format.
- ✓ **Graph** – Displays the parameters in waveform graphs.

- ✓ **Combine** – This option is mostly used in graph merge status for data comparison. In this case, different items are marked in different colors.

**On-screen Buttons:**

 **Graph(Single):** Tap to view the parameter in waveform graph.



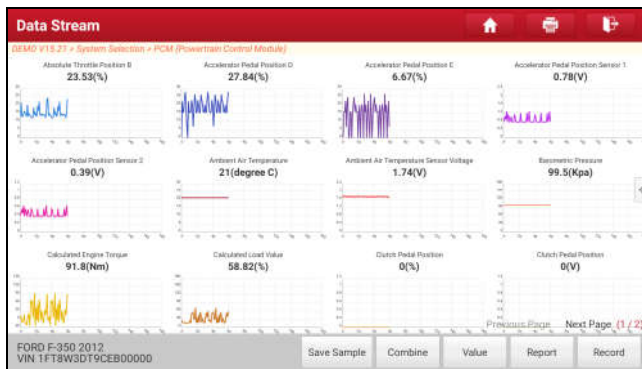

- **Min/Max:** Tap to define the maximum / minimum value. Once the value goes beyond the specified value, the system will alarm.

**Graph:** Tap to view the parameters in waveform graphs.

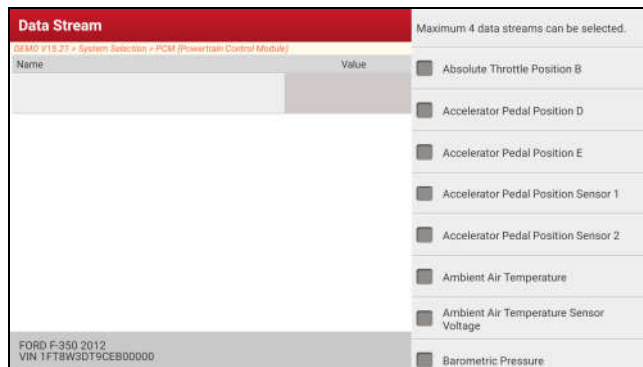

- **Combine:** This option is mostly used in graph merge status for data comparison. In this case, different items are marked in different colors (maximum 4 items can be displayed on the same screen simultaneously). If the graph is more than one page, swipe the screen from the left to jump to the next page.



- **Value:** Switches the current graph display mode to the Value display mode.
- **Customize:** Tap , a pull-down list of the data stream items appears on the screen. Select / deselect the desired items, and then screen will display / remove the waveforms corresponding to these items immediately.

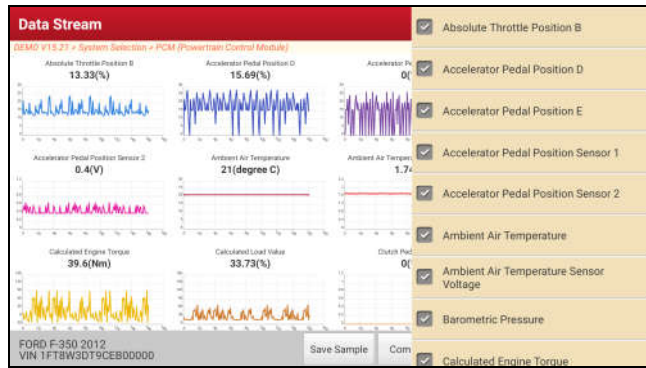

**Compare Sample:** Tap to select the sample DS file.

Name	Value	Standard Range	English	Metric
Absolute Throttle Position B	12.55	0 - 100	%	
Accelerator Pedal Position D	15.69	0 - 100	%	
Accelerator Pedal Position E			%	
Accelerator Pedal Position Sensor 1			V	
Accelerator Pedal Position Sensor 2	0.4	0 - 5	V	
Ambient Air Temperature	21 (1 / 2)	-40 - 215	degree C	

Vehicle Info: FORD F-350 2012, VIN 1FT8W3DT9CEB00000. Buttons: Compare-Sample, Save Sample, Graph, Report, Record, Help.

All the values you customized and saved in process of DS sampling will be imported into the **Standard Range** (See below) column for your comparison.

\*Note: Before executing this function, you have to sample the values of data stream items and save it as a sample Data Stream file.

Name	Value	Standard Range(Data Stream Sample)	English	Metric
Absolute Throttle Position B	21.96	12.55 - 15	%	
Accelerator Pedal Position D	15.69	0 - 13.6	%	
Accelerator Pedal Position E	15.69	0 - 20.4	%	
Accelerator Pedal Position Sensor 1	0.78	0.78 - 1.08	V	
Accelerator Pedal Position Sensor 2	0.4	0.39 - 0.48	V	
Ambient Air Temperature	21 (1 / 2)	21 - 21	degree C	

Vehicle Info: FORD F-350 2012, VIN 1FT8W3DT9CEB00000. Buttons: Compare Sample, Save Sample, Graph, Report, Record, Help.

**Report:** Tap to save the current data in text format. All reports are saved in **User Info -> My Report -> Health Reports**. For details on report operations, please refer to Chapter 10.1.

**Record:** Tap to start recording diagnostic data. Recorded live data can serve as valuable information to help you in troubleshooting of vehicle problems.

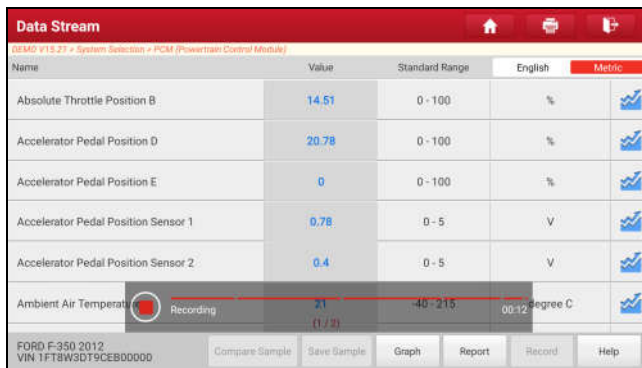

Tap to end recording and save it. The saved file follows the naming rule: It begins with vehicle type, and then the product S/N and ends with record starting time (To differentiate between files, please configure the accurate system time).

All diagnostic records can be replayed from **User Info -> My Report -> Recorded Data**.

**Save Sample:** This item enables you to customize the standard range of live data stream items and save it as DS sample file. Each time you run the data stream items, you can call out the corresponding sample data to overwrite the current standard range.

Tap it to start recording the sample data (\*Note: Only data stream items with measurement units will be recorded), the following screen will appear:

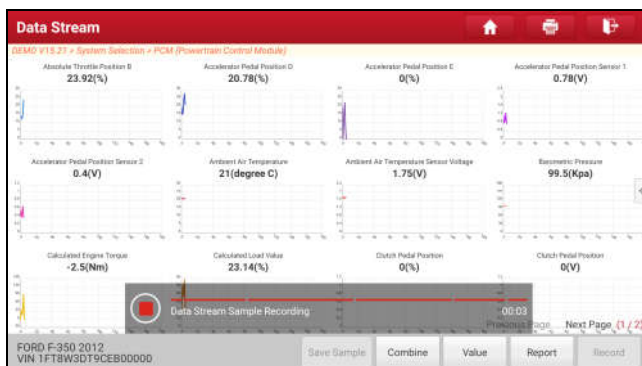

Once the recording process is complete, tap to stop it and navigate to the data revision screen.

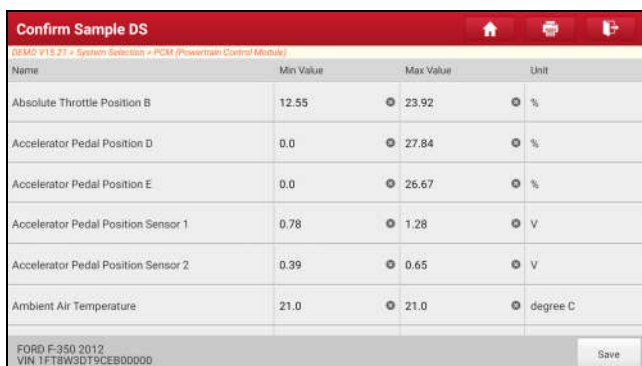

Tap the Min./Max. value to change it. After modifying all desired items, tap **Save** to save it as a sample DS file. All DS files are stored in **User Info -> Data Stream Sample**.

**E. Actuation Test**

This option is used to access vehicle-specific subsystem and component tests. Available test vary by vehicle

manufacturer, year, and model.

During the actuation test, the display tablet outputs commands to the ECU in order to drive the actuators, and then determines the integrity of the system or parts by reading the ECU data, or by monitoring the operation of the actuators, such as switching an injector between two operating states.

On the diagnostic function selection screen, tap **Actuation Test**, the system will display as follows:

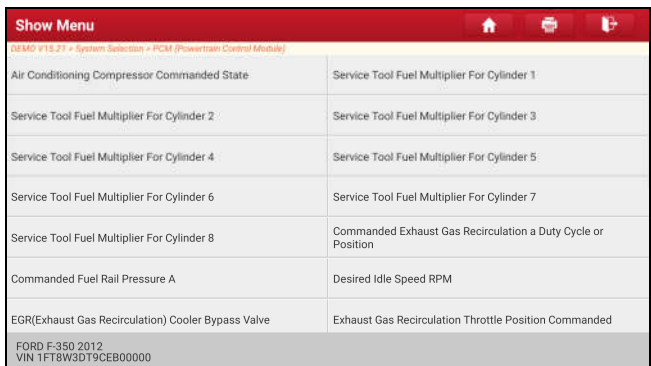

Simply follow the on-screen instructions and make appropriate selections to complete the test.

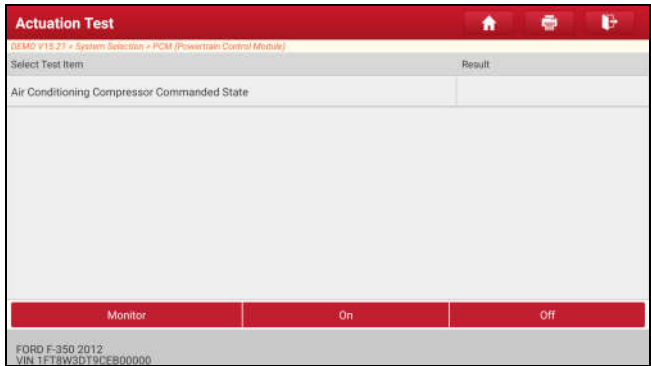

Each time when an operation is successfully executed, "Completed" displays.

**F. Special Function**

In addition to amazing & powerful diagnostic function, the tool also features various reset functions, which varies from vehicle to vehicle.

### 5.3 Remote Diagnose

This option aims to help repair shops or technicians launch instant messaging and remote diagnosis, making the repair job getting fixed faster.

Tap **Remote Diagnose** on the Job menu, the screen appears blank by default.

#### 5.3.1 Interface Layout

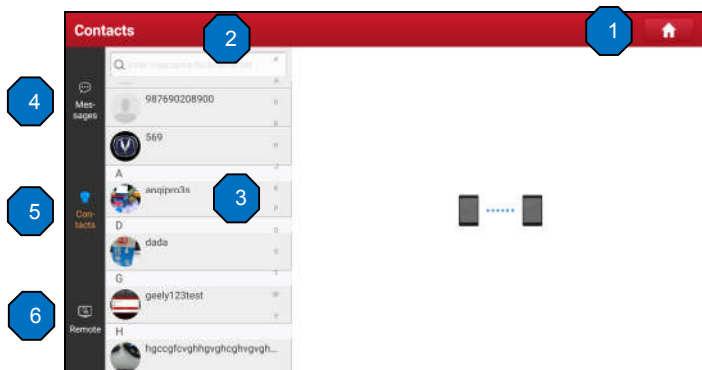

1	Home button	Tap it to navigate to the Job menu screen.
2	Search bar	Directly input the registered username of the tool to start searching, and then tap the desired one to add it into your friend list.
3	Friend list display area	By default it appears blank.
4	Message tab	Once an incoming message reaches, a red dot will appear on the upper right corner of the tab.
5	Contact tab	Tap to enter the friend list.
6	Remote switch	Tap to slide the switch to ON, the tool keeps online and becomes accessible on the web client. In this case, inform the technician of your product S/N, and he/she will control your device remotely.

#### 5.3.2 Add Friends

Tap **Contact** to enter the contact page. By default it appears blank.

In the search bar, input the partner’s username and tap **Search** button next to the search bar to starts searching from Launch’s golo business database.

The partner must be the users who have registered their Launch’s diagnostic tools. They may be the following:

- Workshop
- Technician
- golo users

Once the result matches the keyword, a screen similar to the following will appear:



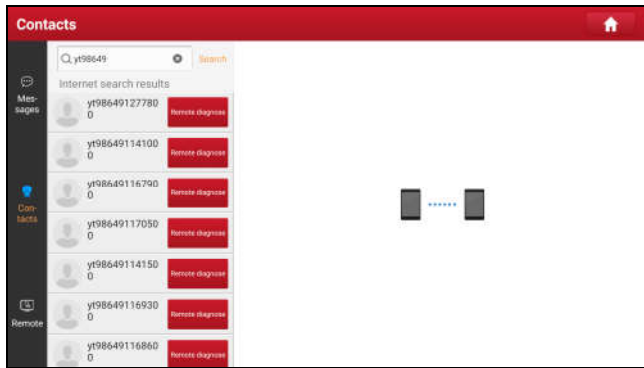

Tap **Remote Diagnose** to launch remote diagnostics directly or follow the steps below to add the partner into the Contacts list.

Tap the desired name from the list, the following screen appears:

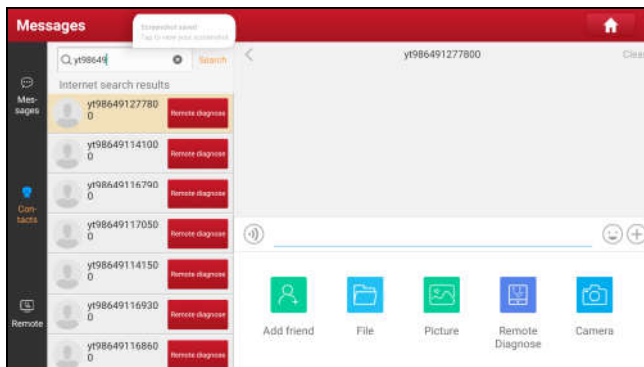

Tap **Add friend**, a dialog box pops up:



Tap **CONFIRM** to send your request.

Once the partner receives the request, a beep will sound. Tap the **Message** tab:

- Once the partner agreed your request, he/she will automatically be listed in the Contact tab.
- If a technician sent you a friend request, tap **Agree** and his/her name will appear in the friend list (Contact). Or tap **Ignore** to ignore this request.

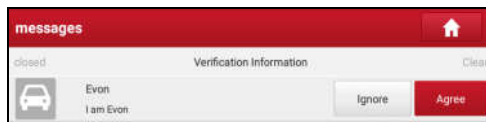

### 5.3.3 Start Instant Messaging

\*Note: The I/M (Instant Messaging) function is open to all users who had Launch’s diagnostic tool equipped with this module.

After adding your friends, tap the desired one’s photo to enter a screen similar to the following figure:

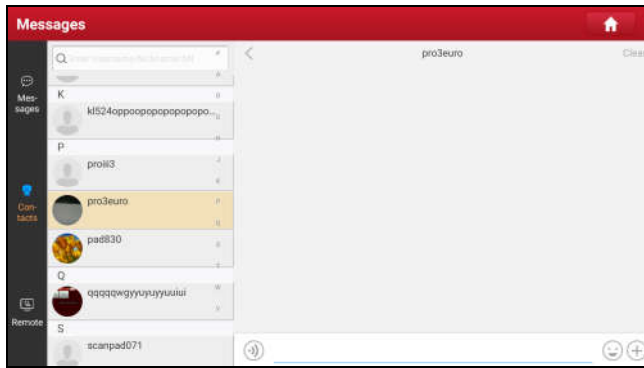

Tap the input field and use the on-screen keyboard to enter the text message, and then tap **Send** to send it.

Tap 🗣️ to send the voice message.

Tap 😊 to send the emoji.

Tap ➕ to call out more function options.

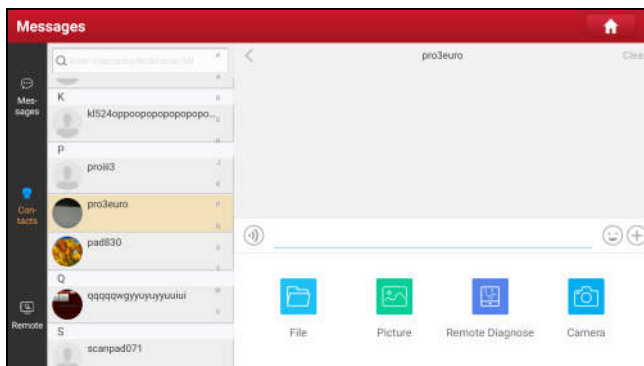

File: Choose diagnostic reports or local files to send.

Picture: Choose screenshots or pictures to send.

Remote Diagnose: To start a remote diagnostic session. For details, refer to Chapter 5.3.4.

Camera: Open camera to take pictures.

Tap **Clear** to delete all the partner's dialog logs.

Tap **Close** to close the current dialog.

### 5.3.4 Launch Remote Diagnosis (Device-To-Device)

The tool is allowed to initiate remote diagnosis with other diagnostic tools (including but not limited to the X-431 PRO5 of Launch family, which are equipped with this module.



\* Note: Before performing this operation, please make sure the following no matter which side sends the remote request:

- Turn on the vehicle power supply.
- Throttle should be in a closed position.
- The tool should be properly connected to the vehicle's DLC and a successful communication is required.

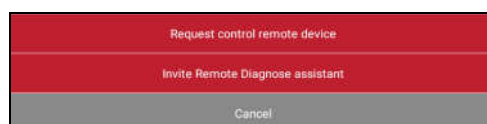
On the function option selection screen, tap **Remote Diagnostic**, a pull-down menu including the following options appears:

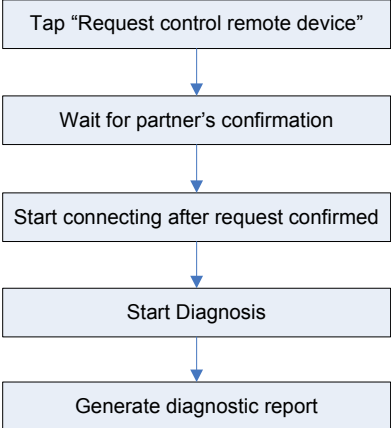

These options are defined as follows:

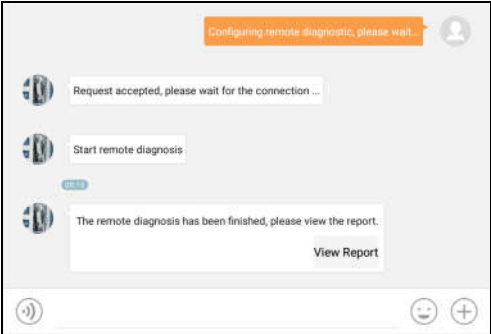
Actions	Results
Request control remote device	<p>Request to control the partner's device remotely to help him diagnose the vehicle.</p> <p>*Notes:</p> <ul style="list-style-type: none"> <li>• Remote diagnosis has the same diagnostic steps as manual diagnosis.</li> <li>• In process of remote diagnosis, tap the  button to send a voice message.</li> <li>• Once vehicle diagnosis is complete, a report will be created. Input your comments on this report, and then tap <b>Send Report</b> to send it to the partner.</li> </ul>  <pre> graph TD     A[Tap "Request control remote device"] --&gt; B[Wait for partner's confirmation]     B --&gt; C[Start connecting after request confirmed]     C --&gt; D[Start Diagnosis]     D --&gt; E[Generate diagnostic report]     </pre>
Invite remote diagnostic assistant	<p>If you need support, just use this option to invite a technician to perform a remote control on your tool.</p> <p>*Notes:</p> <ul style="list-style-type: none"> <li>• Remote diagnosis has the same diagnostic steps as manual diagnosis.</li> <li>• In process of remote diagnosis, tap the  button to send voice message.</li> <li>• Once you received the report from the partner, tap <b>View Report</b> to view its details. All diagnostic reports are saved in <b>User Info -&gt; My Reports -&gt; Remote Reports</b>.</li> </ul> 

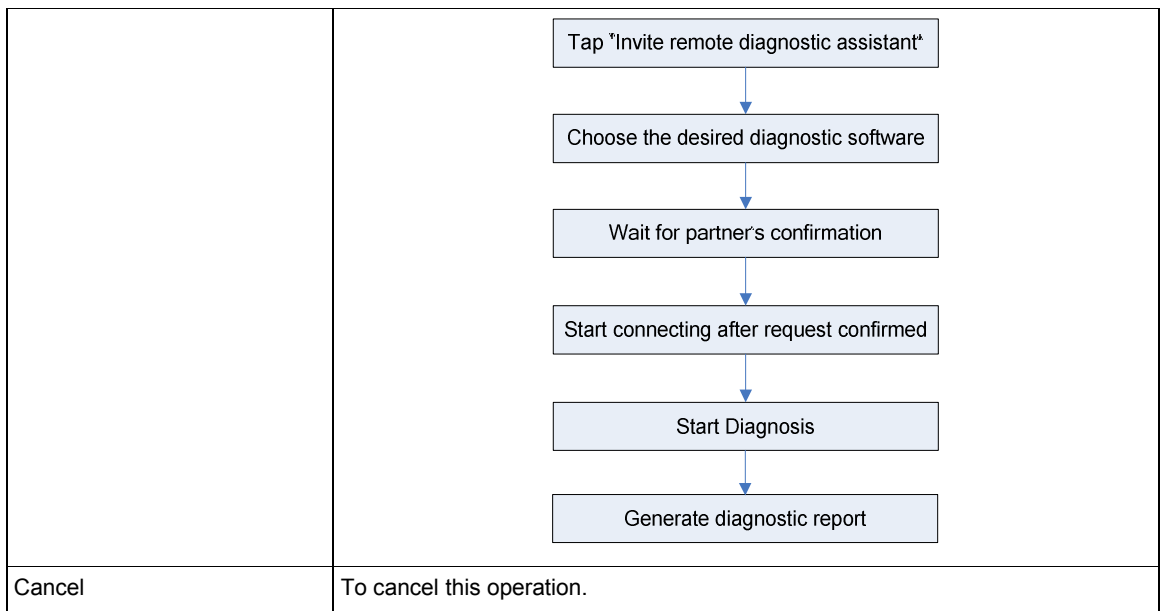

**5.3.5 Launch Remote Diagnosis (Device-To-PC)**

Except that the remote diagnosis can be done between different Launch’s diagnostic tools that come loaded with the module, user also can ask for remote control from PC client technician.

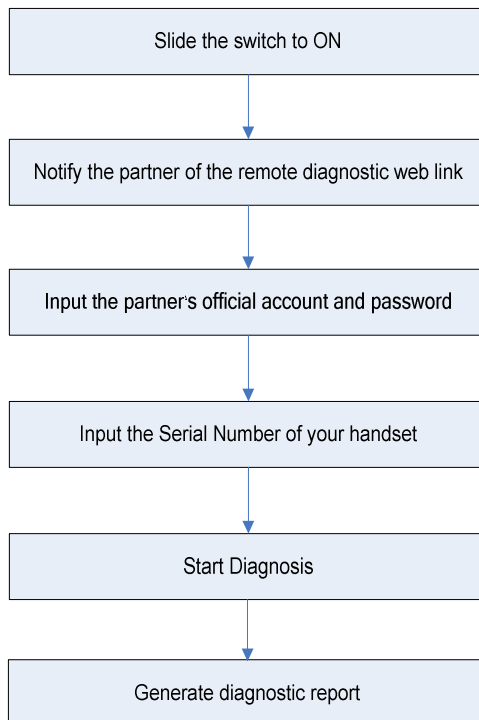

Tap the **Remote** tab, the screen displays as follows:

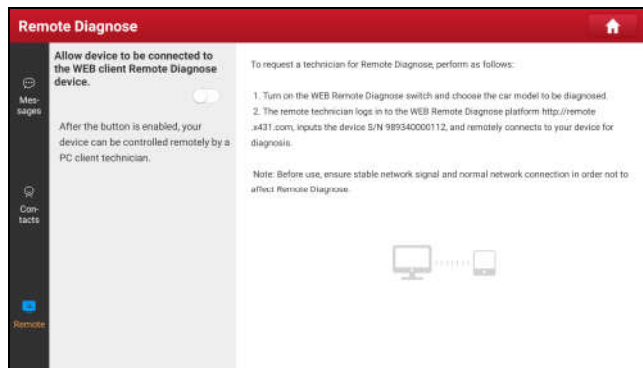

1. Slide the switch **Allow device to be connected to the WEB client remote diagnostic device** to ON so that the partner can find and connect to this device while using the PC.
2. Notify the partner of the PC client website <http://remote.x431.com>. When the partner accesses the link, the PC displays as below:

\*Note: Before processing remote diagnosis, please make sure the tool is properly connected to the vehicle.

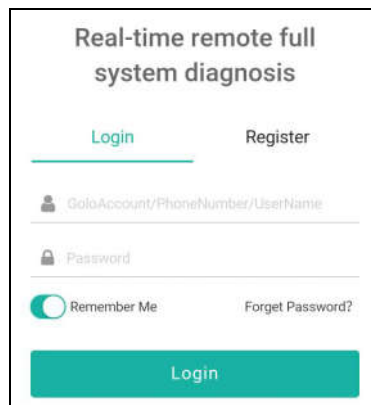

3. Tell the partner to input his own official technician account and password, and then tap **Login** to navigate to the following figure.

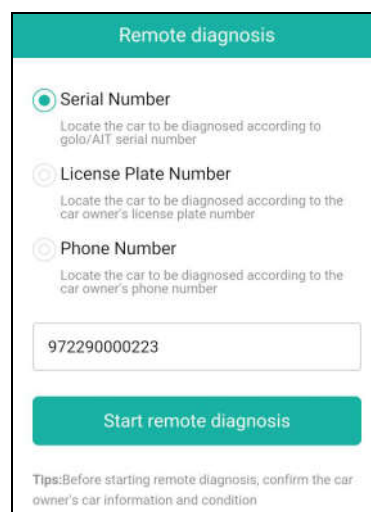

4. Tell the partner to check the box **Serial number** and enter the Serial Number provided by you, and then tap **Start remote diagnosis** to control your device remotely.

In process of remote diagnosis, please note the following things:

- 1) You are not suggested to execute any actions.
- 2) The partner is not allowed to save any diagnostic reports or records on your handset.

The operations in remote diagnosis are same as those in local diagnose. Once the session is complete, a remote diagnostic report will be automatically generated.

### 5.4 Feedback

This item allows you to feedback your diagnostic problems to us for analysis and troubleshooting.

Tap **Feedback**, a pop-up message will appear:

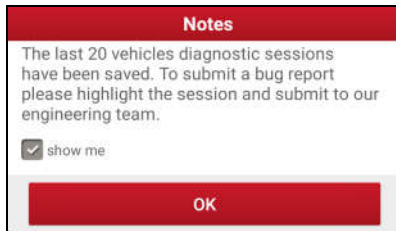

Tap **OK**, the following 3 options will be displayed on the left column of the screen.

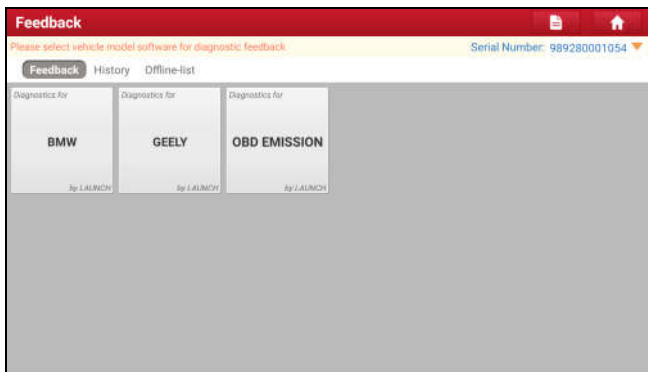

#### A. Feedback

Tap certain tested vehicle model to enter the feedback screen.

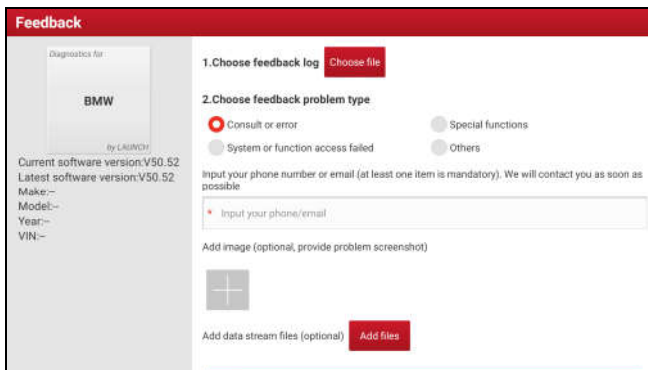

- 1) Tap **Choose File** to open the target folder and choose the desired diagnostic logs.
- 2) Choose the failure type and fill in the detailed failure description in the blank text box and telephone or email address. After inputting, tap **Submit Result** to send it to us.

#### B. History

Tap it to view all diagnostic feedback records. Different process states are marked with different colors.

### C. Offline list

Tap it to display all diagnostic feedback logs which have not been submitted successfully due to network failure. Once the handset gets a stable network signal, it will be uploaded to the remote server automatically.

## 5.5 Diagnostic History

Generally once a vehicle diagnosis is performed, the tool will record the every details of diagnostic process. The History function provides direct access to the previously tested vehicles and users can resume from the last operation, without starting from scratch.

Tap **Diagnostic History** on the Job menu screen, all diagnostic records will be listed on the screen in date sequence.



- Tap certain vehicle model to view the details of the last diagnostic report.
- To delete certain diagnostic history, select it and then tap **Delete**. To delete all historical records, tap **Select All** and then tap **Delete**.
- Tap **Quick Access** to directly navigate to the function selection page of last diagnostic operation. Choose the desired option to proceed.

## 6 Special (Reset) Function

Except that the special functions can be performed from the diagnostic menus (See Chapter 5.2.3) of certain vehicle model, this module provides an easy dial to quickly access the special functions.

The most commonly performed service functions contain:

- Oil Reset Service
- Electronic Parking Brake Reset
- Steering Angle Calibration
- ABS Bleeding
- TPMS (Tire Pressure Monitor System) Reset
- Gear Learning
- IMMO Service
- Injector Coding
- Battery Maintenance System
- Diesel Particulate Filter (DPF) Regeneration
- Electronic Throttle Position Reset
- Gearbox Matching
- AFS (Adaptive Front-lighting System) Reset
- Sunroof Initialization
- Suspension Calibration

There are two methods to reset service lamp: Manual reset or Auto reset. Auto reset follows the principle of sending command from the tool to vehicle's ECU to do resetting. While using manual reset, users just follow the on-screen instructions to select appropriate execution options, enter correct data or values, and perform necessary actions, the system will guide you through the complete performance for various service operations.

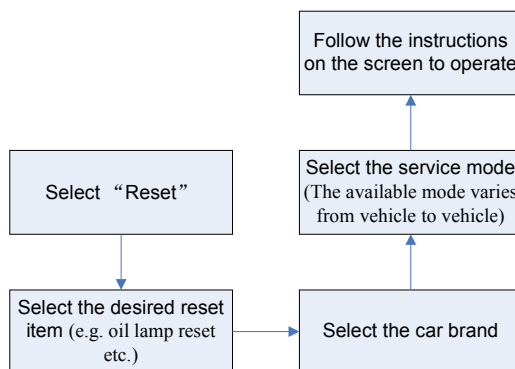

### 6.1 Oil Reset Service

This function allows you to perform reset for the engine oil life system, which calculates an optimal oil life change interval depending on the vehicle driving conditions and climate.

This function can be performed in the following cases:

1. If the service lamp is on, you must provide service for the car. After service, you need to reset the driving mileage or driving time so that the service lamp turns off and the system enables the new service cycle.
2. After changing engine oil or electric appliances that monitor oil life, you need to reset the service lamp.

### 6.2 Electronic Parking Brake Reset

1. If the brake pad wears the brake pad sense line, the brake pad sense line sends a signal sense line to the on-board computer to replace the brake pad. After replacing the brake pad, you must reset the brake pad.



Otherwise, the car alarms.

2. Reset must be performed in the following cases:
  - a) The brake pad and brake pad wear sensor are replaced.
  - b) The brake pad indicator lamp is on.
  - c) The brake pad sensor circuit is short, which is recovered.
  - d) The servo motor is replaced.

### 6.3 Steering Angle Calibration

To reset the steering angle, first find the relative zero point position for the car to drive in straight line. Taking this position as reference, the ECU can calculate the accurate angle for left and right steering.

After replacing the steering angle position sensor, replacing steering mechanical parts (such as steering gearbox, steering column, end tie rod, steering knuckle), performing four-wheel alignment, or recovering car body, you must reset the steering angle.

### 6.4 ABS Bleeding

This function allows you to perform various bi-directional tests to check the operating conditions of Anti-lock Braking System (ABS).

1. When the ABS contains air, the ABS bleeding function must be performed to bleed the brake system to restore ABS brake sensitivity.
2. If the ABS computer, ABS pump, brake master cylinder, brake cylinder, brake line, or brake fluid is replaced, the ABS bleeding function must be performed to bleed the ABS.

### 6.5 Tire Pressure Monitor System Reset

This function allows you to quickly look up the tire sensor IDs from the vehicle's ECU, as well as to perform TPMS replacement and sensor test.

1. After the tire pressure MIL turns on and maintenance is performed, the tire pressure resetting function must be performed to reset tire pressure and turn off the tire pressure MIL.
2. Tire pressure resetting must be performed after maintenance is performed in the following cases: tire pressure is too low, tire leaks, tire pressure monitoring device is replaced or installed, tire is replaced, tire pressure sensor is damaged, and tire is replaced for the car with tire pressure monitoring function.

### 6.6 Gear Learning

The crankshaft position sensor learns crankshaft tooth machining tolerance and saves to the computer to more accurately diagnose engine misfires. If tooth learning is not performed for a car equipped with Delphi engine, the MIL turns on after the engine is started. The diagnostic device detects the DTC P1336 'tooth not learned'. In this case, you must use the diagnostic device to perform tooth learning for the car. After tooth learning is successful, the MIL turns off.

After the engine ECU, crankshaft position sensor, or crankshaft flywheel is replaced, or the DTC 'tooth not learned' is present, tooth learning must be performed.

### 6.7 IMMO Service

An immobilizer is an anti-theft mechanism that prevents a vehicle's engine from starting unless the correct ignition key or other device is present. Most new vehicles have an immobilizer as standard equipment. An important advantage of this system is that it doesn't require the car owner to activate it since it operates automatically. An immobilizer is considered as providing much more effective anti-theft protection than an audible alarm alone.

As an anti-theft device, an immobilizer disables one of the systems needed to start a car's engine, usually the ignition or the fuel supply. This is accomplished by radio frequency identification between a transponder in the ignition key and a device called a radio frequency reader in the steering column. When the key is placed in the ignition, the transponder sends a signal with a unique identification code to the reader, which relays it to a receiver

in the vehicle's computer control module. If the code is correct, the computer allows the fuel supply and ignition systems to operate and start the car. If the code is incorrect or absent, the computer disables the system, and the car will be unable to start until the correct key is placed in the ignition.

To prevent the car being used by unauthorized keys, the anti-theft key matching function must be performed so that the immobilizer control system on the car identifies and authorizes remote control keys to normally use the car.

When the ignition switch key, ignition switch, combined instrument panel, ECU, BCM, or remote control battery is replaced, anti-theft key matching must be performed.

## 6.8 Injector Coding

Write injector actual code or rewrite code in the ECU to the injector code of the corresponding cylinder so as to more accurately control or correct cylinder injection quantity.

After the ECU or injector is replaced, injector code of each cylinder must be confirmed or re-coded so that the cylinder can better identify injectors to accurately control fuel injection.

## 6.9 Battery Maintenance System Reset

This function enables you to perform a resetting operation on the monitoring unit of vehicle battery, in which the original low battery fault information will be cleared and battery matching will be done.

Battery matching must be performed in the following cases:

- a) Main battery is replaced. Battery matching must be performed to clear original low battery information and prevent the related control module from detecting false information. If the related control module detects false information, it will invalidate some electric auxiliary functions, such as automatic start & stop function, sunroof without one-key trigger function, power window without automatic function.
- b) Battery monitoring sensor. Battery matching is performed to re-match the control module and motoring sensor to detect battery power usage more accurately, which can avoid an error message displaying on the instrument panel.

## 6.10 Diesel Particulate Filter (DPF) Regeneration

DPF regeneration is used to clear PM (Particulate Matter) from the DPF filter through continuous combustion oxidation mode (such as high temperature heating combustion, fuel additive or catalyst reduce PM ignition combustion) to stabilize the filter performance.

DPF regeneration may be performed in the following cases:

- a) The exhaust back pressure sensor is replaced.
- b) The PM trap is removed or replaced.
- c) The fuel additive nozzle is removed or replaced.
- d) The catalytic oxidizer is removed or replaced.
- e) The DPF regeneration MIL is on and maintenance is performed.
- f) The DPF regeneration control module is replaced.

## 6.11 Electronic Throttle Position Reset

This function enables you to make initial settings to throttle actuators and returns the "learned" values stored on ECU to the default state. Doing so can accurately control the actions of regulating throttle (or idle engine) to adjust the amount of air intake.

## 6.12 Gearbox Matching

1. This function can complete the gearbox self-learning to improve gear shifting quality.
2. When the gearbox is disassembled or repaired (after some of the car battery is powered off), it will lead to shift delay or impact problem. In this case, this function needs to be done so that the gearbox can automatically compensate according to the driving conditions so as to achieve more comfortable and better shift quality.

### **6.13 AFS (Adaptive Front-lighting System) Reset**

This feature is used to initialize the adaptive headlamp system. According to the ambient light intensity, the adaptive headlamp system may decide whether to automatically turn on the headlamps, and timely adjust the headlamp lighting angle while monitoring the vehicle speed and body posture.

### **6.14 Sunroof Initialization**

This function can set the sunroof lock off, closed when it rains, sliding / tilting sunroof memory function, temperature threshold outside the car etc.

### **6.15 Suspension Calibration**

1. This function can adjust the height of the body.
2. When replacing the body height sensor in the air suspension system, or control module or when the vehicle level is incorrect, you need to perform this function to adjust the body height sensor for level calibration.

## 7 SmartLink Diag.

### 7.1 Introduction

SmartLink is a newly developed powerful service system dedicated to remote vehicle diagnosis and service. In the SmartLink ecology system, if a technician (SmartLink C) does not have time to puzzle through a touch vehicle problem, he can seek a trusted second opinion or additional expertise on various puzzle vehicle issues from remote master technicians or repair shops (SmartLink B). SmartLink B enables the shop owner to greatly increase customer's retention and boost shop revenue by providing the professional technical assistance service.

It mainly consists of the following parts:

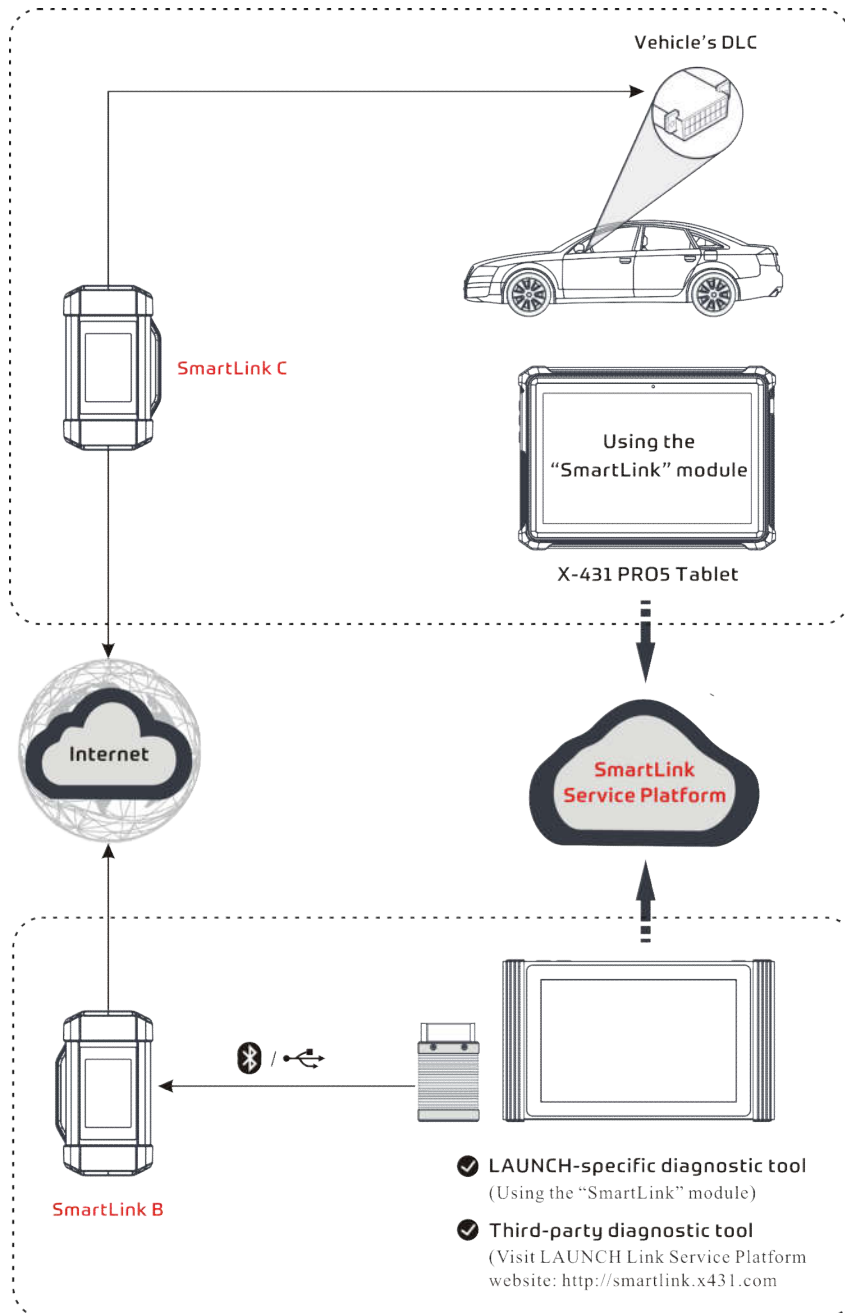

- **SmartLink Service Platform** – It can be accessed from the **SmartLink** module of the tablet. There are two modules available on the link service platform: **I'd like a remote assistance** (for SmartLink C) and **I am a remote technician** (for SmartLink B).
- **SmartLink C (Customer) - SmartLink Service Subscriber.** In the SmartLink system, the SmartLink A has an **I'd like a remote assistance** module on the SmartLink Service Platform for submitting remote repair orders plus a SmartLink A dongle for accessing vehicle data. It supports remote diagnostic services for vehicles that meet CAN / CAN FD / J2534 vehicle diagnostic standards.

1). Launch Service Link Platform: Binds SmartLink C dongles and submits remote repair orders.

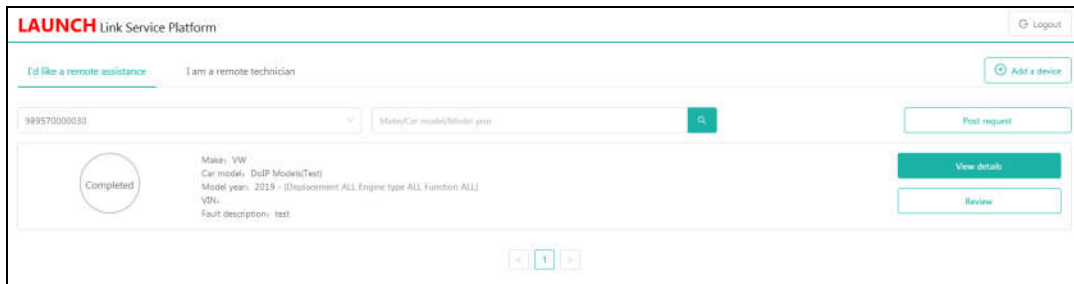

2). SmartLink C Dongle: Connects to the vehicle's DLC port for collecting the vehicle data and sends it to the remote SmartLink B.

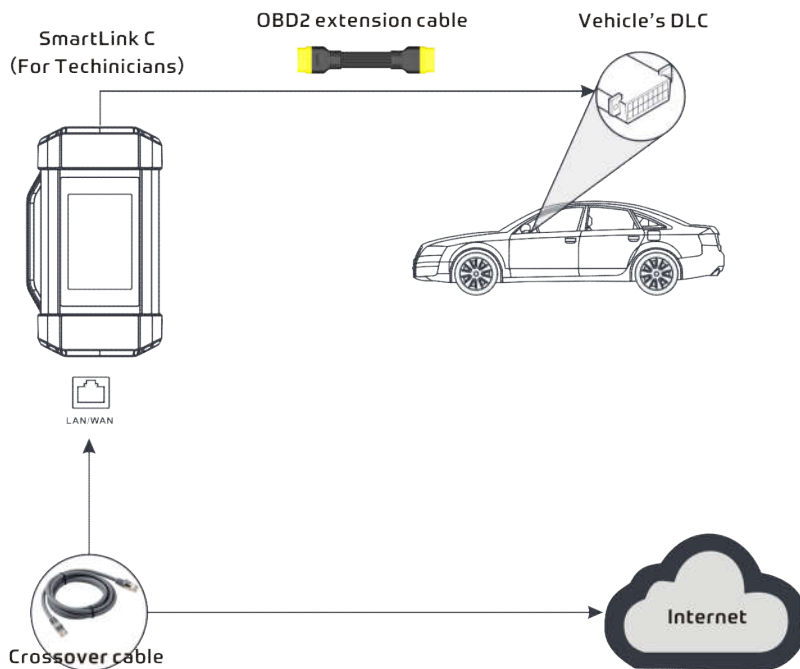

- **SmartLink B (Business) - SmartLink Service Provider.** In the SmartLink system, the SmartLink B has an **I am a remote technician** module on the SmartLink Service Platform for accepting the orders from SmartLink C plus a SmartLink B dongle for providing hardware support.

1). Launch Service Link Platform: Binds SmartLink B dongles and accepts orders from SmartLink C.

- If the SmartLink B dongle works with the LAUNCH-specific diagnostic tool equipped with SmartLink module, tap **SmartLink** to add the SmartLink B device and accepts orders on the diagnostic tool.
- If the SmartLink B dongle works with the third-party diagnostic tool, open the browser and visit SmartLink Service Platform website <http://smartlink.x431.com> (web client) to add the SmartLink B device and accepts orders in the browser.

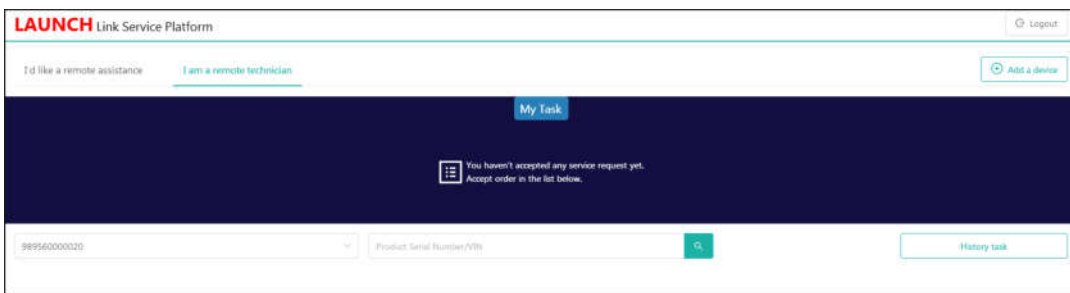

2). SmartLink B Dongle: After accepting the orders, it can work with the compatible diagnostic tool to perform diagnosis of the vehicle connected to the SmartLink C dongle.

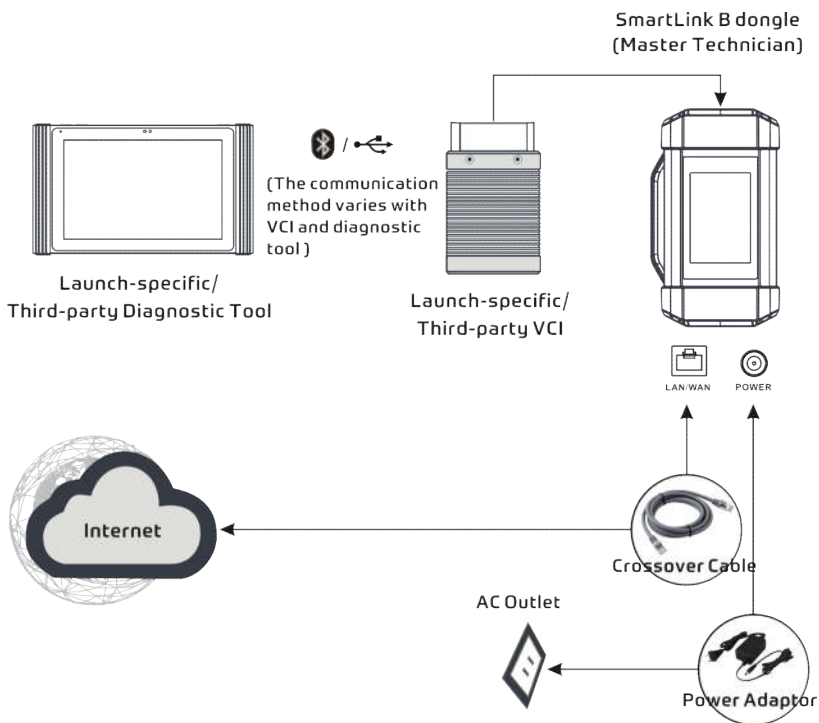

## 7.2 Perform SmartLink Remote Operation

### 7.2.1 Posting remote assistance request

1. Tap **SmartLink** on the Job menu of the tablet. The tablet automatically logs in the SmartLink system.



On-screen buttons:

- **Logout:** Exits the current account from the system.
- **Add a device:** Binds more SmartLink C device to the current account.
- **Post request:** Submits a new remote assistance order.

2. Tap the **Post Request** button to fill in the following information.

- In the **Device S/N** column, choose the desired SmartLink C Serial Number from the pull-down list if several SmartLink C is bound to the current account.
- In the **Vehicle information** column, enter the VIN manually and choose the right Make, Car model, Model year, Displacement, Engine type and Function.  
 \*Note: In general, vehicle identification numbers are standardized - all contain 17 characters. VIN characters may be capital letters A through Z and numbers 1 through 0; however, the letters I, O and Q are never used in order to avoid mistakes of misreading. No signs or spaces are allowed in the VIN.
- In the **Contact information** column, input the phone number, E-mail address and name so that you can be reached by the remote SmartLink B in the shortest time.
- In the **Problem Description** input box, it is highly recommended to describe the vehicle failure as accurate as possible because it is very helpful for the SmartLink B to have a general understanding of the vehicle status.
- Tap **Link Platform Register Protocol** to read it carefully. After reading it, select the checkbox "I agree."

3. After filling the information, tap **Submit** to create the order.

On-screen buttons:

- **View details:** Double check if the order information is correct or not.
- **Review:** Rates the service that has been already finished.

4. Next refer to Chapter 7.2.2 to make connections and start the diagnosis.

\*Note: The remote SmartLink operation can only be performed after the SmartLink C has submitted the request, and this request has been accepted by the remote SmartLink B.

**7.2.2 Connections & operations**

Follow the steps below to proceed:

1. Turn off the vehicle ignition.
2. Connect one end of the OBD II extension cable into the OBD-16 diagnostic port of the SmartLink C device, and the other end into the vehicle's DLC port.

\*Remarks: During the SmartLink diagnosis, especially during remote online programming, it is recommended that the vehicle battery is connected to a charging power source. Doing so can prevent the vehicle from running out of power and failing to start due to long diagnosis time.

3. Plug one end of CAT-6 crossover cable into the LAN/WLAN port of the SmartLink C device, and the other end into the LAN port of network modem.

\*Note: The network broadband of 100MB and above is required for this operation.

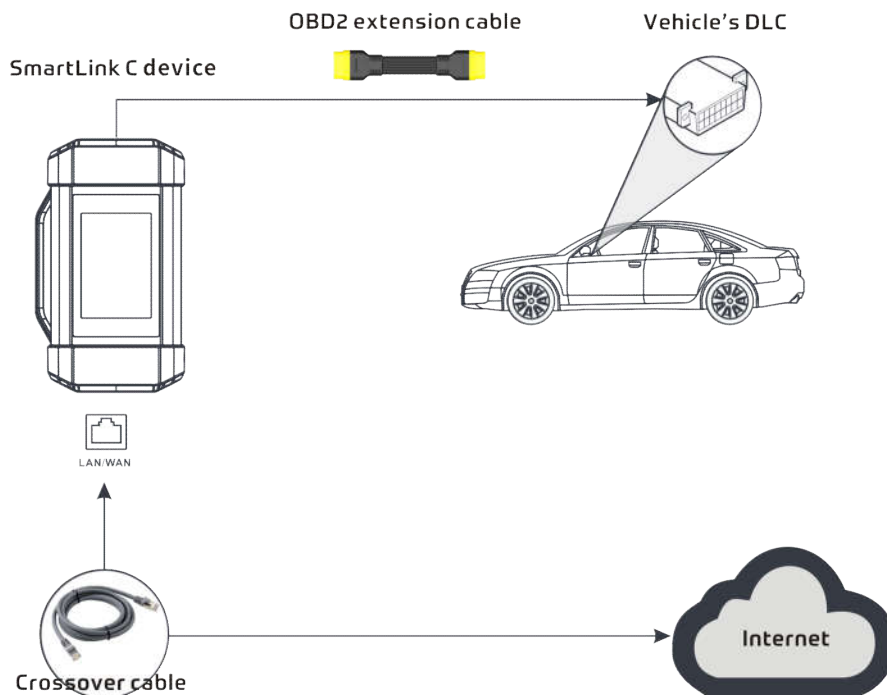

4. After a successful network connection, the SmartLink C screen displays prompt information asking whether to enter the super remote diagnostic mode. Tap **Yes**, the system will automatically read the vehicle information and connect to the remote diagnosis server.

\*Note: One SmartLink C can only accept one remote diagnostic operation at one time.

5. Turn on the vehicle ignition.

\*Remarks: After receiving the order, the SmartLink B master technician will accept the order and contact you via phone or E-mail address.

6. After a successful connection between the SmartLink C and SmartLink B is established, the following message will be displayed on the SmartLink C screen.



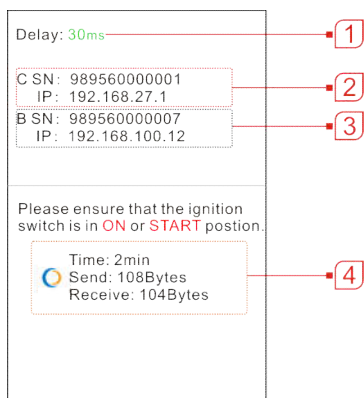

1	<p>Network delay status: Indicates the quality of the current network. Different colors represent different delay status. There are three states of network delay:</p> <ul style="list-style-type: none"> <li>• <b>Green:</b> Indicates the network is normal. It is recommended that the diagnosis operation be performed when the network delay is green. Otherwise, the communication with the vehicle may fail or the incorrect system detection may occur.</li> <li>• <b>Yellow:</b> Indicates the network is not stable. Please keep it stable.</li> <li>• <b>Red:</b> Indicates the network delay is serious and not suitable for remote diagnosis or the network is disconnected.</li> </ul> <p>*Remarks: If the displayed network is poor, there may be too many people using the network in the LAN and some users are downloading. It is recommended to use a stable network for remote diagnosis.</p>
2	The Serial Number and IP address of the current SmartLink C device.
3	The Serial Number and IP address of the connected SmartLink B device.
4	The duration of diagnosis process and package size of sent data/received data.

\*Notes:

- Please do not interrupt the vehicle or network connection during a remote diagnostic process.
  - Please make sure that the network delay is in green state when performing a remote online programming process.
7. Unplug the crossover cable when a SmartLink operation is completed.

## 8 Software Update

This module allows you to update the diagnostic software & App and set frequently used software.

If you did not download the software in process of product registration or a pop-up message prompting you that some new software can be updated, you may use this option to download it or keep it synchronized with the latest version.

### 8.1 Update Diagnostic Software & APP

Tap **Software Update** on the Job menu to enter the update center.

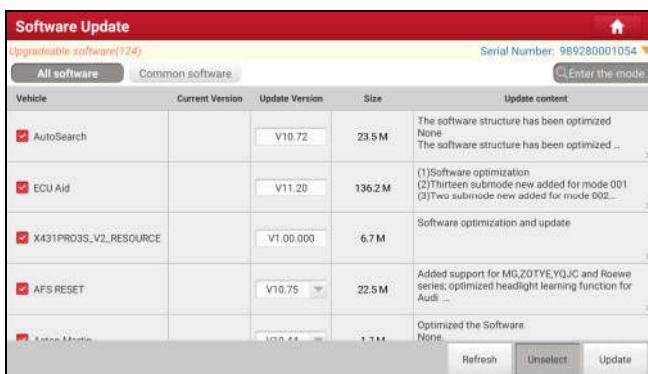

By default, all diagnostic software is selected. To deselect certain software, tap **Unselect**, and then check the box next to vehicle model. Tap **Update** to start downloading.

It may take several minutes to finish it, please be patient to wait.

To pause downloading, tap **Stop**. To resume it, tap **Continue**. If network connection failure occurs, tap **Retry** to try again.

Once download is finished, the software packages will be installed automatically.

### 8.2 Set Frequently Used software

This function enables you to easily locate and quickly update some frequently used software.

Tap **Common Software** to create a frequently used software list.

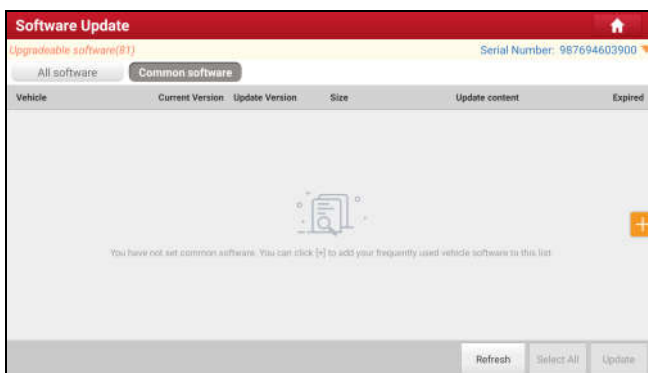

Tap  on the right edge of the screen, a pop-up window appears.

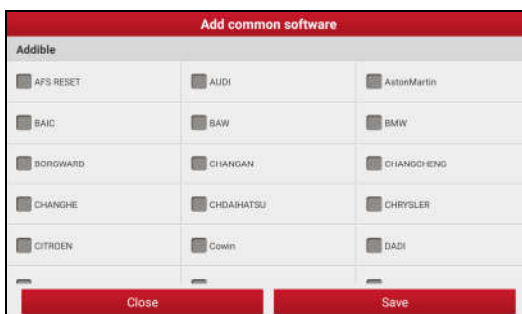

Select the checkbox before the software name and tap **Save**, the software will be displayed in the Common software list. Next time you want to update it, just go to **Common software**.

### 8.3 Renew Subscription

If the software subscription is due or expires, the system will prompt you to renew your subscription and a **Renewal** button will appear on the bottom of the update page.

Tap **Renewal** to navigate to the payment screen.

There are two ways available for you to make payment: PayPal and Subscription Renewal Card (\*need to buy it from the local dealer where you purchased the tool).

#### A. Using PayPal

1. Tap **Renewal** on the update page to navigate to the renewal type selection screen.
2. Select **PayPal**, and then follow the on-screen instructions to finish the transaction.
3. After payment, go to update center to update the diagnostic software.

#### B. Using Subscription Renewal Card

1. Tap **Renewal** to navigate to the renewal type selection screen.
2. Select **Subscription Renewal Card**.

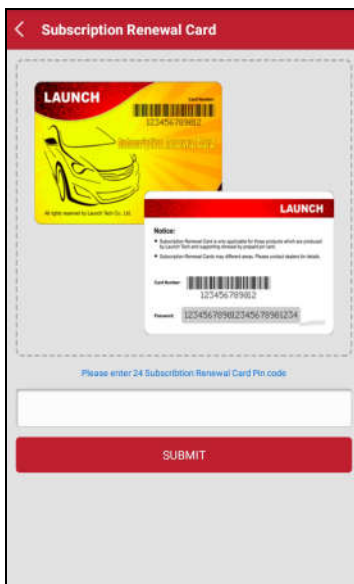
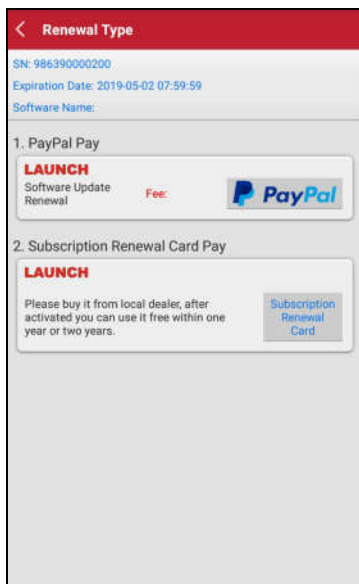

3. Input the 24-digit pin code of Subscription Renewal Card and then tap **Submit** to finish the renewal.
4. Go to update center to update the diagnostic software.

## 9 ADAS

Advanced Driver Assistance Systems (ADAS) are electronic components in vehicles, which include a wide range of safety features for vehicles such as autonomous emergency braking (AEB), lane departure warning (LDW), lane keep assist, blind spot elimination, night vision cameras and adaptive lighting.

The cameras and sensors used by these systems have to be precisely calibrated and adjusted. Incorrect calibration resulting from windscreen replacement or wheel alignment can cause the system to deliver incorrect results or even fail completely, resulting in a serious accident or even a fatality.

The ADAS feature on the tablet is disabled by default and user needs to activate this feature with the Activation Code (optional) before performing this function. Moreover, it also requires the tablet to work with the X-431 ADAS PRO calibration tool manufactured by LAUNCH (calibration tools from other manufacturers will not be supported). As a comprehensive and flexible calibration tool, the X-431 ADAS PRO calibration tool enables you to effectively and accurately calibrate a wide range of camera-based & radar-based driver assistance systems, e.g. the front camera for the lane departure warning system, the radar sensor for the ACC (Adaptive Cruise Control) or the camera for adaptive headlights.

Follow the steps below to activate it.

1. Tap **ADAS** on the Job menu.

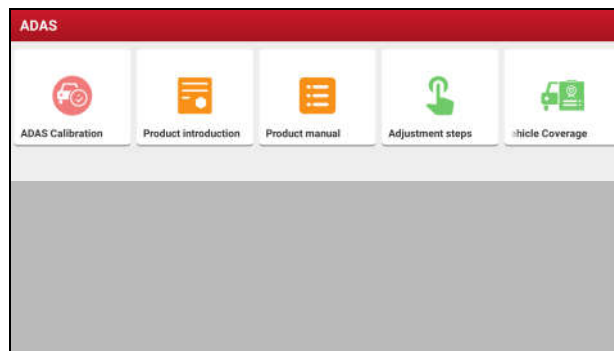

The following functions are included in this module:

- **ADAS Calibration:** This option allows you to activate the ADAS function on this tool.
- **Product Introduction:** A brief introduction of the X-431 ADAS PRO calibration tool.
- **Product Manual:** The user manual of the X-431 ADAS PRO calibration tool is available for easy retrieval and reference.
- **Adjustment Steps:** The detailed adjustment steps on how to calibrate the X-431 ADAS PRO calibration tool.
- **ADAS Vehicle Coverage:** To check all vehicle models that the X-431 ADAS PRO calibration tool covers.

2. Tap **ADAS Calibration** to until the following screen appears.



3. Scratch or scrap the designated area on the Activation Card to reveal the password, and input the 24-digit password to activate it.

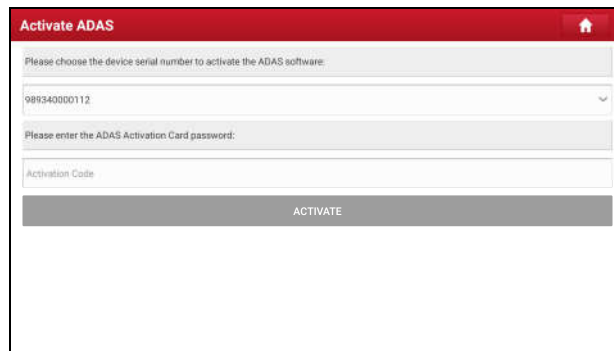

**Activate ADAS**

Please choose the device serial number to activate the ADAS software:

98934000112

Please enter the ADAS Activation Card password:

Activation Code

ACTIVATE

4. Now the ADAS function becomes accessible and is ready for use.

## 10 User Info

This function allows users to manage personal information and VCI.

### 10.1 My Report

This option is used to view, delete or share the saved reports.

Tap **My Report**, there are total 3 options available.

1). If the DTC result is saved on Read Trouble Code page, the files will be listed under **Health Reports** tab.

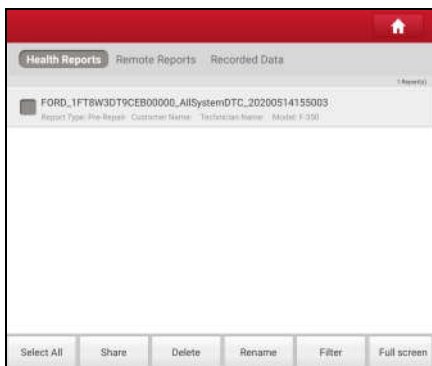

All diagnostic reports are sorted by Date and Make. Tap the desired type to re-arrange and filter it.

- To select certain report, check the box before the report. To select all reports, tap **Select All**. To deselect all, tap **Unselect**.
- To share the report with others, select the desired one and then tap **Share**.
- Select the desired report and then tap **Delete** to delete it.
- To change the filename of report, tap **Rename**.
- To quickly locate the desired report, tap **Filter**.
- To exit the full screen, tap **Exit full screen**.

2). **Remote Reports** lists all diagnostic reports generated in process of remote diagnosis.

3). If user records the running parameters while reading data stream, it will be saved as .x431 file and appear under **Recorded Data** tab.

Tap the desired one to enter. Select the desired data stream items and tap **OK** to jump to the playback page:



#### On-screen Buttons:

**Graph** – displays the parameters in waveform graphs.

**Value** – this is the default mode which displays the parameters in texts and shows in list format.

**Combine** – this option is mostly used in graph merge status for data comparison. In this case, different items are

marked in different colors.

**Frame Playback** – plays back the recorded data stream items frame by frame. Once it is in frame playback mode, this button changes into **Auto Playback**.

### 10.2 VCI

This option allows you to manage all your activated VCI devices.

If several VCI devices are activated on this tool, a list of VCIs will be displayed on the screen. Once you choose the VCI that belongs to other account, you have to log out, and then input the right account to continue.

### 10.3 VCI Management

This option is used for the tablet to deactivate pairing up with the VCI device via Bluetooth.

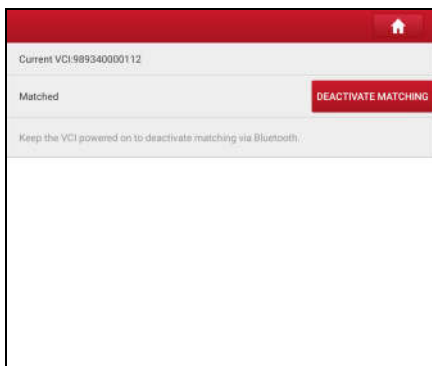

\*Note: please be sure to keep the VCI powered on while performing the operation.

### 10.4 Activate VCI

This item lets you to activate a new VCI device.

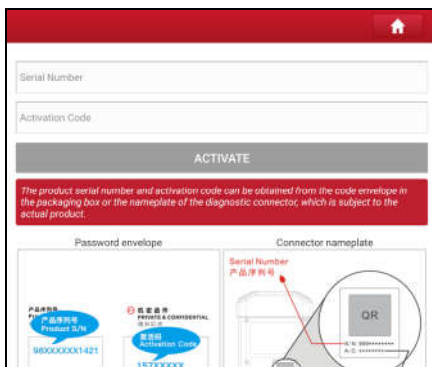

Input the Serial Number and Activation Code, and then tap **Activate** to activate the VCI.

For details on how to obtain Activation Code, tap the link below to get help.

### 10.5 Firmware Fix

Use this item to upgrade and fix diagnostic firmware. During fixing, please do not cut power or switch to other interfaces.

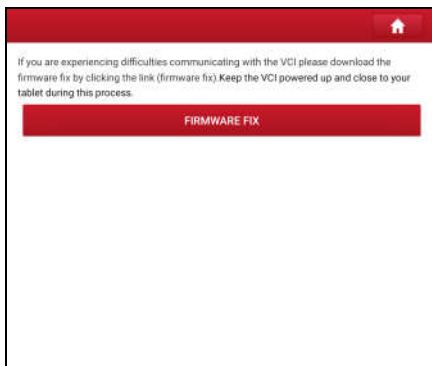

### 10.6 My News

This option allows you to receive some commercial and promotional activity messages.

### 10.7 Data Stream Sample

This feature allows you to manage the recorded data stream sample files.

### 10.8 My Order

This item allows you to check the status of all your orders.

### 10.9 Subscription Renewal Card

This item is used to check the status of the subscription renewal card.

Input the 12-digit subscription renewal card number. Tap **Search** to get the search result.

### 10.10 Profile

Use this item to view and configure personal information.



- Tap the user image to change it.
- Tap > next to **Upgrade Period** to check the due date of all diagnostic software.

### 10.11 Change password

This item allows you to modify your login password.

### 10.12 Settings

It enables you to make some application settings and login/logout etc.



**10.12.1 Units**

It is designed to configure the measurement unit. Metric System and English System are available.

**10.12.2 Shop Information**

This option lets you define your print information. It mainly includes Workshop, Address, Telephone, Fax and License Plate.



After inputting, tap **Save**.

Once you saved the print information, it will be entered automatically in the “Add Information” box every time you save the diagnostic report.

**10.12.3 Printer Set**

This option enables you to establish a wireless connection between the tablet and Wi-Fi printer while performing printing operations.

The App is compatible with the “LAUNCH Wi-Fi Printer” (sold separately) and “System” (external printer).

**For LAUNCH Wi-Fi mini printer**, follow the steps below to connect the printer.

1. Tap **Printer Set**.

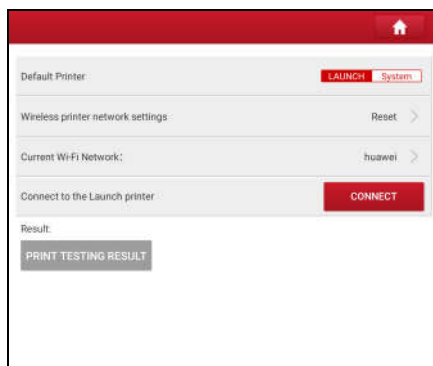

A. If it is the first time you have operated this printer, please proceed the following:

1. For initial use, you are suggested to reset the printer: Press and hold [MODE] & [FEED] for 8 seconds, the following resetting command will be printed out:

```
at + default = 1
ok
at + reboot = 1
rebooting...
```

2. Tap **Reset** to configure Wi-Fi printer.

Step 1: Connect the printer:

Tap **Scan** to start scanning and select the desired printer hotspot named with X-431PRINTER-XXXX (XXXX stands for 4 characters), and then tap **Connect** to enter Step 2.

Step 2: Join the Wi-Fi printer into LAN:

Tap **Scan** to select the desired local Wi-Fi network from the list, and type in the security password (If it is an open network, password is not required), and then tap **Confirm**.

3. Once the Wi-Fi network of the printer is connected and the printer is found, tap **Printing test** to test the printing. Now the Wi-Fi printer is ready for printing.

If the printer is not found, please reset the printer to default factory settings (refer to Step 2 for details) and check whether the current device and the printer are on the same LAN.

B. If you have configured the Wi-Fi printer to the LAN:

2. Tap **Connect to Printer:**

- a). If the local network remains as it is, tap **Test Print** directly to test the printing.
- b). If the local network changes, you have to reset the Wi-Fi printer.

For other Wi-Fi printers.

Before printing, make sure the following conditions are met:

- The Wi-Fi printer is powered on and working normally.
- The print service plug-in associated with the printer is already installed on the tablet (Go to Google Play or use the Browser to download and install it).

Follow the steps below to proceed:

1. Set the default printer as **System**.
2. Go to **Settings -> Network & Internet -> WLAN**, set the WLAN switch to Off.
3. On the report details page, tap 

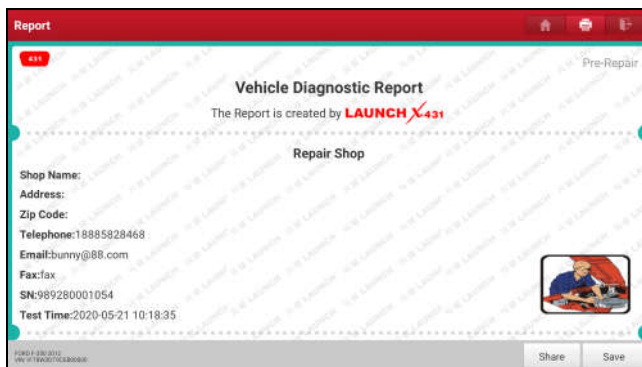

4. Touch ▼ next to **Select a printer** on the upper left corner of the screen.

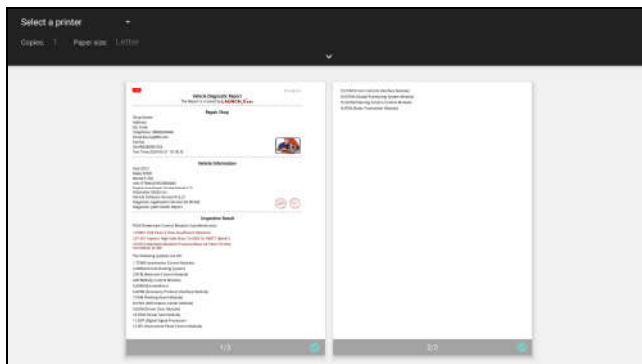

5. Select **All Printers** -> **Add printer** and enable the installed printer service, the system starts searching for all available Wi-Fi printers of the brand.

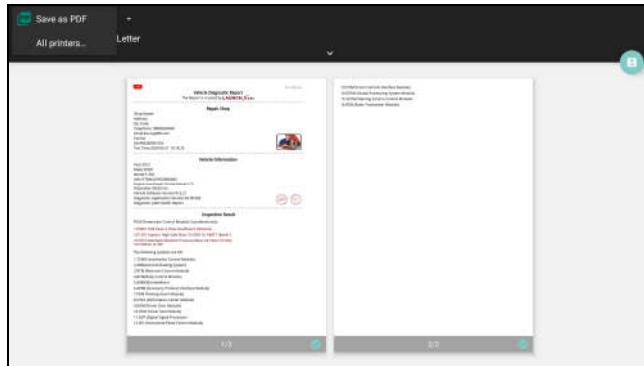

6. Select the desired Wi-Fi printer from the list. If the chosen Wi-Fi printer hotspot is open, the tablet can connect it directly. If it is encrypted, a password may be required. Refer to the Wi-Fi printer user manual to get the default password.
7. Now the printer is ready for printing.
8. Alternatively, you can also choose **Save as PDF** to save the current diagnostic report as a PDF file for later printing.

#### 10.12.4 Clear Cache

This option allows you to clear the App cache. Clearing the cache will restart the App.

#### 10.12.5 About

The software version information and disclaimer are included.

#### 10.12.6 Diagnostic Software Auto Update

This option is used to set whether automatic update function is ON.

#### 10.12.7 Login/Logout

To logout the current user ID, tap **Logout**.

To login the system again, tap **Login**.

### 10.13 Diagnostic Software Clear

This item allows you to hide/clear the diagnostic software that is not frequently used.

\*Note: Removing software may completely delete the software from the tablet. If some software is not used and the tablet runs out of space, you can use this feature to remove it. To re-download it, go to **Software Update** -> **All software**.

## 11 Videoscope

### 11.1 Introduction

Automotive videoscope is mainly applied to those unseen parts of engine, fuel tank, braking system.

While testing a vehicle system, engine is one of the main parts to be checked. To check if the internal of an engine is qualified or not or whether internal carbon deposit and damage exists in the engine or not, we can make full use of a videoscope to solve these questions.

This tool provides an optional function of videoscope (needs to be purchased separately).

The videoscope is mainly composed of an inspection camera, flexible tube and data cable. The water-resistant camera lens with adjustable LED lights enables you to observe the parts that cannot be seen in wet, dark, fluid soaked places. The included flexible tube is convenient for easy inspection and allows for access to hard-to-reach areas.

In addition, the captured pictures and videos also provide you intuitive data for easy analysis.

### 11.2 Connections & Operations

1. Insert the data cable of the videoscope into the charging/data I/O port of port of the tablet.
2. Bend the neck of the flexible tube as desired and extend the camera with adjustable LED lights to some unseen or unreachable parts of engine, hydraulic system, nozzles etc.
3. After connections are properly made and turn the tablet on. Go to **Others -> Videoscope** to run it, then the screen will display the scene captured from the videoscope camera.
5. Adjust it until the lens stops in the desired place and then use the dial for LED light brightness to adjust the brightness.
6. Press the Snapshot button on the videoscope to take a photo. Alternatively, you can also press the Snapshot button on the tablet to take photos.

To record a video, switch from Camera mode to Video mode and tap the Record button on the screen to start recording.

Images are captured in .jpg format and videos are recorded in .avi or .mp4 format. All photographings and videos are saved in DCIM folder where users can browse and replay it.

## 12 J2534 Reprogramming Using SmartLink C

Flash programming has become a common and profitable procedure in the repair and service of today's vehicles. As part of the 21st Century Tune-up, reprogramming is often the only solution for problems ranging from driveability and loss of power to poor fuel economy and emissions related issues. SmartLink C makes it easy. The SmartLink C is a communication interface designed to support J2534 specifications for ECU reprogramming.

Except that the SmartLink C can act as a VCI device and a SmartLink dongle, it also can be used as a J2534 PassThru device, working together with the PC installed with the OEM diagnostic software to perform the J2534 reprogramming. In this case, the PC needs to install with the LAUNCH's J2534 tool, which can be downloaded from the official website at [www.cnlaunch.com](http://www.cnlaunch.com).

### 12.1 As a Local J2534 PassThru Device

Except that the SmartLink C acts as a VCI device and a SmartLink dongle, it also can be used as a J2534 PassThru device, working together with the PC installed with the OEM diagnostic software to perform the J2534 reprogramming. In this case, the PC needs to install with the LAUNCH's J2534 tool, which can be downloaded from [www.cnlaunch.com](http://www.cnlaunch.com).

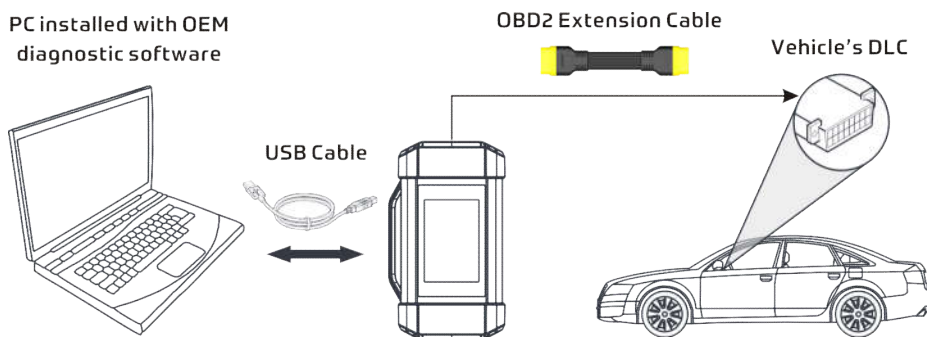

### 12.2 As a Remote J2534 PassThru Device

Besides local ECU reprogramming, remote ECU reprogramming function is also supported using SmartLink C.

\*Before diagnosing, please make sure the following conditions are met:

- The SmartLink C device is connected to the Internet and has a strong network signal.
- The OEM diagnostic software has been installed on the PC.
- The LAUNCH's J2534 tool also needs to be installed on the PC. This tool and its associated operation instruction documentation can be downloaded from [www.cnlaunch.com](http://www.cnlaunch.com).

Ensure that the remote reprogramming operation is performed after the SmartLink C is connected to the vehicle's DLC port and the Internet, and has been switched to the super remote diagnosis mode. For specific operations, please refer to other associated documentation.

PC installed with OEM diagnostic software

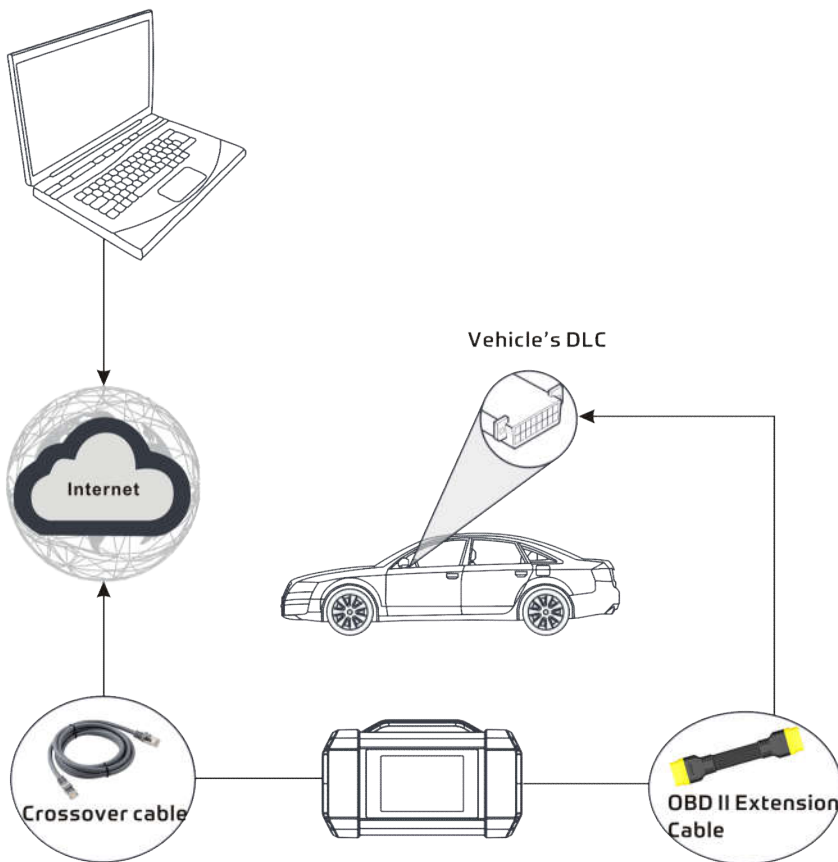

## 13 Synchronization

You can transfer media files, screenshots and APK between the PC and tablet.

1. Connect one end of the included charging/data cable to the charging/data I/O port of the tablet, and the other end to the USB port of the PC.
2. Swipe the tablet screen from the top, a pull-down option list will appear on the screen.

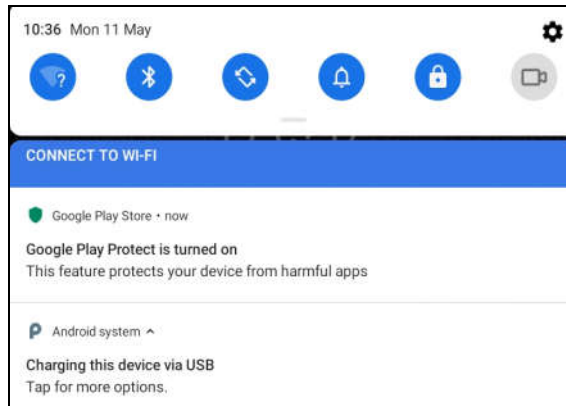

3. Tap **Charging this device via USB**, the following setting options will be displayed on the screen.

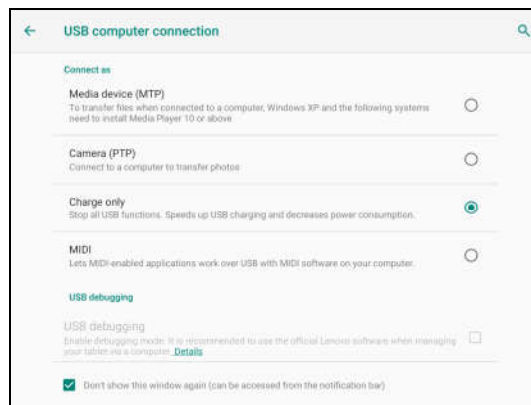

4. Select the checkbox “Media device (MTP)” under the **Connect as** tab.
5. Now you can transfer files between the tablet and PC.

## 14 FAQ

### 14.1 About X-431 PRO5

#### 1. How to save power?

- Please turn off the screen while the tool keeps idle.
- Set a shorter standby time.
- Decrease the brightness of the screen.
- If WLAN connection is not required, please turn it off.

#### 2. Communication error with vehicle ECU?

Please confirm:

1. Whether the VCI is correctly connected.
2. Whether ignition switch is ON.
3. If all checks are normal, send vehicle year, make, model and VIN number to us using Feedback feature.

#### 3. Failed to enter into vehicle ECU system?

Please confirm:

1. Whether the vehicle is equipped with this system.
2. Whether the VCI is correctly connected.
3. Whether ignition switch is ON.
4. If all checks are normal, send vehicle year, make, model and VIN number to us using Feedback feature.

#### 4. How to reset the tablet?

 Resetting may cause data loss. Before doing so, please make sure important data and information has been backed up.

Do the following to reset the tablet:

1. Tap **Settings** -> **Reset options**.
2. Tap **Erase all data (factory reset)**.
3. Tap **RESET TABLET**.
4. Tap **ERASE EVERYTHING** to start resetting until the tool automatically reboots.

#### 5. How to download the X-431 PRO5 App after resetting the tablet?

\*Note: Before registration, please make sure the network is properly connected.

After the tablet has been successfully reset, follow the steps below to download the App:

1. Launch the browser and the default official Launch website opens (If a blank page pops up, just type in [www.x431.com](http://www.x431.com) in the input bar).
2. Tap **Login**, input the username and password and tap **Log In**.
3. Make sure that the serial number is correct, tap **APP application program** and tap the Download icon to start downloading.
4. After the download is complete, follow the on-screen instructions to install it.
5. After installation, use the existing username and password to login and go to update center to download the diagnostic software.

#### 6. What to do if the language of vehicle diagnostic software does not match the system language?

English is the default system language of the tool. After the system language is set to the preference language, please go to the update center to download the vehicle diagnostic software of the corresponding language.

If the downloaded diagnostic software is still displayed in English, it indicates that the software of the current



language is under development.

### **7. How to retrieve the login password?**

Please follow below steps to proceed in case you forgot the login password:

1. Tap the application icon on the home screen to launch it.
2. Tap the **Login** button on the upper right corner of the screen.
3. Tap **Retrieve password**.
4. Input product S/N and follow the on-screen prompts to retrieve the password.

## **14.2 About SmartLink Diag.**

### **1. What's network conditions is required for SmartLink Diag.?**

The remote SmartLink Diag. operation requires a network broadband of 100 MB or above.

### **2. What does the word "Delay" displayed on the SmartLink C screen mean?**

The Delay (network delay) indicates the quality of the current network. Different colors represent different delay status. There are three states of network delay:

**Green:** Indicates the network is normal. It is recommended that the diagnosis operation be performed when the network delay is green. Otherwise, the communication with the vehicle may fail or the incorrect system detection may occur.

**Yellow:** Indicates the network is not stable. Please keep it stable.

**Red:** Indicates the network delay is serious and not suitable for remote diagnosis or the network is disconnected.

### **3. Why is the network connection so poor?**

If the displayed network is poor, there may be too many people using the network in the LAN and some users are downloading. It is recommended to use a stable network for remote SmartLink diagnosis.

### **4. Why does the sign appear on the upper right corner of the SmartLink C screen?**

Some networks have firewall restriction which leads to a longer delay of connection. You are most likely to see this sign while your system is in connection with networks managed by communities or companies. It is recommended to use the networks directly installed by telecommunication operators where there is no firewall restriction.

### **5. Some systems of some old vehicles cannot be tested**

The SmartLink C device supports CANBUS and DoIP communication protocols, but some old vehicle uses K-Line communication protocol.

### **6. Is it necessary to re-ignite the car after the diagnostic system starts working?**

For the sake of some vehicle's conditions, the re-ignition will provide you a more detailed analysis after OBD diagnosis.

### **7. Can I charge the SmartLink C device through an external DC power supply?**

No. The SmartLink C device obtains power only through a vehicle's OBD diagnostic socket. Getting power through an external DC power supply could result in system malfunction.

### **8. How to update SmartLink C system?**

After the SmartLink C device is powered on and connected to the network, a message "Whether to upgrade now?" will be displayed if a new system version is detected. Tap **Yes** to start updating, wait until the upgrade is complete.

## 15 Glossary of Terms & Abbreviations

**ABS** – Anti-Lock Brake System

**ADAS** -- Advanced Driver Assistance Systems

**AFS** – Adaptive Front-lighting System

**CAN** – Controller Area Network

**Communication Protocol** – Allows different systems and sensors in a vehicle to communicate.

There are currently five Protocols:

- CAN Bus
- J1850 VPW
- ISO 9141-2
- J1850 PWM
- ISO 14230 KWP

**DC** – Direct Current

**DLC** – Data Link Connector

The 16-cavity connector on the vehicle that allows communication between the computer system and the diagnostic tool.

**DPF** – Diesel Particulate Filter

**DTC** – Diagnostic Trouble Code

A code stored in the computer system's memory, which helps to identify the fault condition that is causing the MIL to activate.

**Drive Cycle** – A set of driving procedures that, when met, provide the Enabling Criteria for the I/M Monitors to run and complete their diagnostic tests.

**Freeze Frame Data** – A digital representation of engine and/or emissions system conditions present when a fault code was recorded.

**Generic Code** – A DTC that applies to all OBD2 compliant vehicles.

**I/M** – Instant Messaging.

**I/M Readiness** – An indication of whether or not a vehicle's emissions-related system are operating properly and are ready for Inspection and Maintenance testing.

**LCD** – Liquid Crystal Display

**LED** – Light Emitting Diode

**Manufacturer Specific Code** – A DTC that applies only to OBD II-compliant vehicles made by a specific manufacturer.

**MIL** – Malfunction Indicator Lamp

The vehicle's "Check Engine" warning light that activates when a DTC is stored.

***OBD I*** – On-Board Diagnostics Version 1

***OBD II*** – On-Board Diagnostics Version 2

***OEM*** – Original Equipment Manufacturer

***PID*** – Parameter Identification Data

Data returned by the vehicle's Control Modules to the diagnostic tool.

***TPMS*** – Tire Pressure Monitor System

***VCI*** – Vehicle Communication Interface

***WLAN*** – Wireless Local Area Network

---

## Warranty

THIS WARRANTY IS EXPRESSLY LIMITED TO PERSONS WHO PURCHASE LAUNCH PRODUCTS FOR PURPOSES OF RESALE OR USE IN THE ORDINARY COURSE OF THE BUYER'S BUSINESS.

LAUNCH electronic product is warranted against defects in materials and workmanship for one year from date of delivery to the user.

This warranty does not cover any part that has been abused, altered, used for a purpose other than for which it was intended, or used in a manner inconsistent with instructions regarding use. The exclusive remedy for any automotive meter found to be defective is repair or replacement, and LAUNCH shall not be liable for any consequential or incidental damages.

Final determination of defects shall be made by LAUNCH in accordance with procedures established by LAUNCH. No agent, employee, or representative of LAUNCH has any authority to bind LAUNCH to any affirmation, representation, or warranty concerning LAUNCH automotive meters, except as stated herein.

## Disclaimer

The above warranty is in lieu of any other warranty, expressed or implied, including any warranty of merchantability or fitness for a particular purpose.

## Purchase Order

Replaceable and optional parts can be ordered directly from your LAUNCH authorized tool supplier. Your order should include the following information:

- Order quantity
- Part number
- Part name

## Customer Service

Any question during the operation, please call +86-755-84557891 or send Email to our official after-sale service email address: [overseas.service@cnlaunch.com](mailto:overseas.service@cnlaunch.com).

If your unit requires repair service, return it to the manufacturer with a copy of the sales receipt and a note describing the problem. If the unit is determined to be in warranty, it will be repaired or replaced at no charge. If the unit is determined to be out of warranty, it will be repaired for a nominal service charge plus return freight. Send the unit pre-paid to:

Attn: Customer Service Department  
LAUNCH TECH CO., LTD.  
Launch Industrial Park,  
North of Wuhe Avenue,  
Banxuegang, Bantian,  
Longgang, Shenzhen, Guangdong  
P.R.China, 518129  
Launch website: <http://www.cnlaunch.com>  
<http://www.x431.com>

## Statement:

LAUNCH reserves the rights to make any change to product designs and specifications without notice. The actual object may differ a little from the descriptions in the manual in physical appearance, color and configuration. We have tried our best to make the descriptions and illustrations in the manual as accurate as possible, and defects are inevitable, if you have any question, please contact local dealer or after-sale service center of LAUNCH, LAUNCH does not bear any responsibility arising from misunderstandings.